

ME240/ ME340

**THERMAL TRANSFER / DIRECT THERMAL
BAR CODE PRINTER**

**SERVICE
MANUAL**

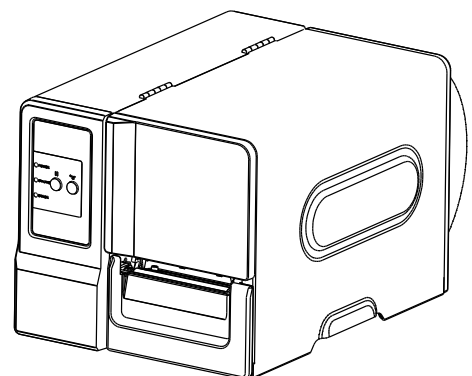

TABLE OF CONTENT

1. FUNDAMENTAL OF THE SYSTEM	1
1.1. Overview.....	1
2. ELECTRONICS.....	5
2.1 Summary of Board Connectors.....	5
2.2 Pin Configuration.....	9
3. MECHANISM	11
3.1 Remove the Electronics Cover	11
3.2 Remove the Right Side Cover.....	12
3.3 Replacing the Key/LCD Panel Module	13
3.4 Replacing the Main Board.....	14
3.5 Replacing the Power Supply Unit.....	16
3.6 Replacing the Stepping Motor	17
3.7 Replacing the Platen Roller Assembly.....	18
3.8 Replacing the Print head ASS'Y	20
3.9 Replacing the Media Sensor Module.....	22
3.10 Replacing the Ribbon End Sensor Module.....	23
3.11 Replacing the Ribbon Encoder Sensor Module	24
3.12 Centronics Parallel Interface Board Installation (Option)	26
3.13 Cutter Module Installation (Option).....	28
3.14 Peel-off Module Installation (Option)	30
3.15 Print Engine Module Specification (Option)	32
4. TROUBLESHOOTING	34
4.1 Common Problems.....	34
4.2 Print Head Pressure Adjustment Knob.....	38
4.3 Mechanism Fine Adjustment to Avoid Ribbon Wrinkles	39
4.4 Z-axis Mechanism Adjustment Knob	41
5. MAINTENANCE.....	43
UPDATE HISTORY	45

1. FUNDAMENTAL OF THE SYSTEM

1.1. Overview

Front View



- 1. LED indicators
- 2. Pause key
- 3. Feed key
- 4. Paper exit chute
- 5. Lower front cover
- 6. Media viewer
- 7. Printer right side cover opener
- 8. LCD (Option)
- 9. Keys for LCD module (Option)

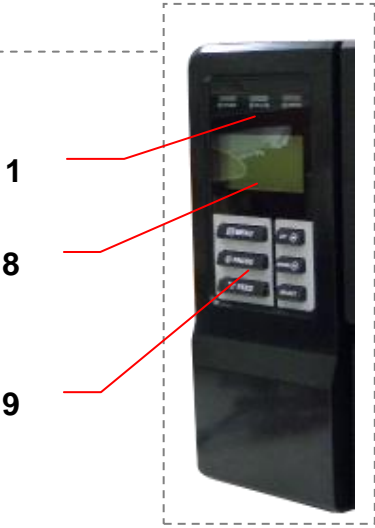

Interior View

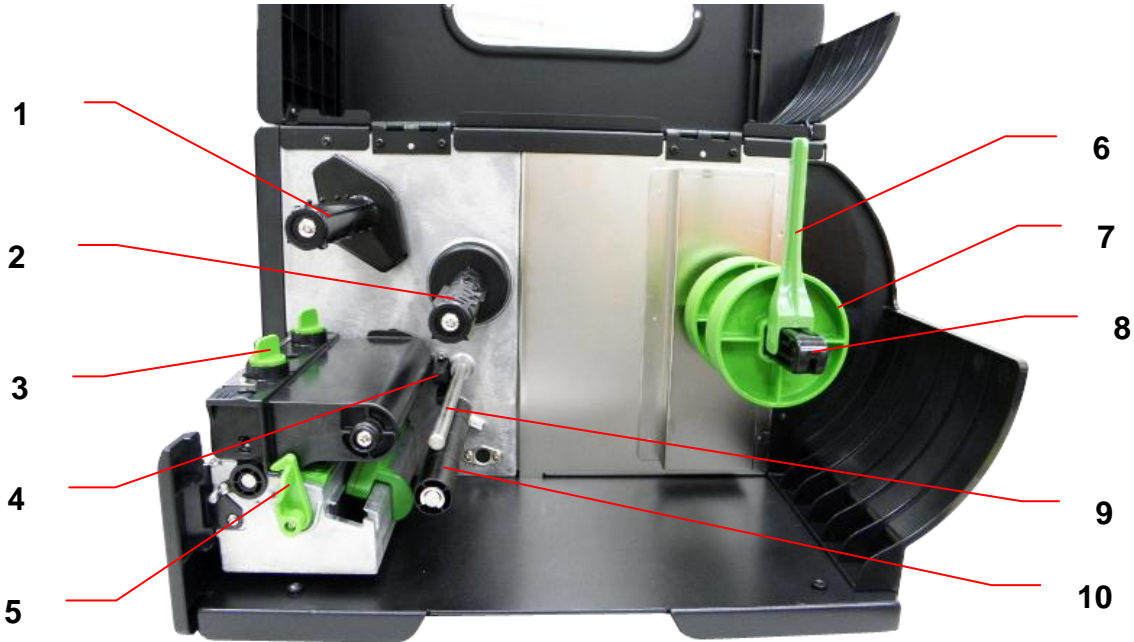

- 1. Ribbon rewind spindle
- 2. Ribbon supply spindle
- 3. Print head pressure adjustment knob
- 4. Ribbon end sensor
- 5. Print head release lever
- 6. Label roll guard
- 7. 3" core adapter
- 8. Label supply spindle
- 9. Ribbon guide bar
- 10. Media guide bar



- 11. Print head
- 12. Platen roller
- 13. Media sensor
- 14. Label guide

Rear View

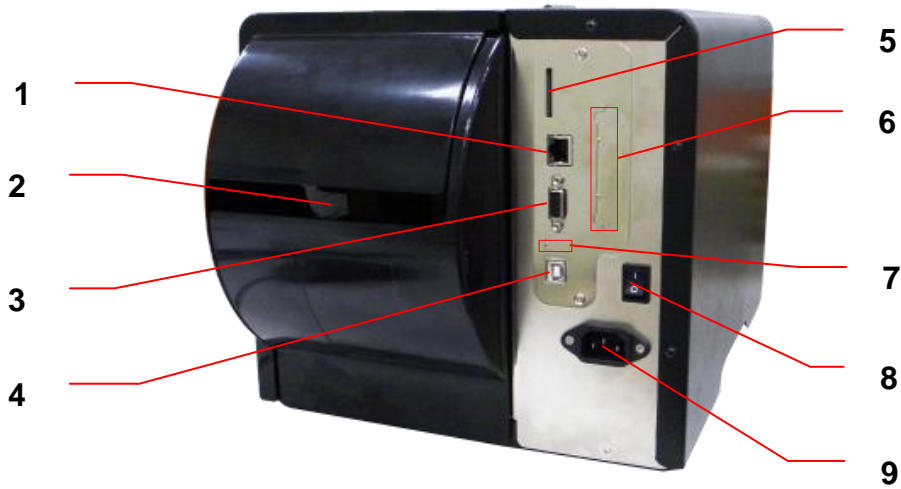

1. Internal Ethernet interface (Option)
2. Fan-fold paper entrance chute
3. RS-232C interface (Max. 115,200 bps)
4. USB interface (USB 2.0/ Full speed mode)
- *5. SD card slot
6. Centronics interface (Option)
7. USB host (Option)
8. Power switch
9. Power jack socket

Note:

The interface picture here is for reference only. Please refer to the product specification for the interfaces availability.

*** Recommended SD card specification.**

SD card spec	SD card capacity	Approved SD card manufacturer
V1.0, V1.1	128 MB	SanDisk, Transcend
V1.0, V1.1	256 MB	SanDisk, Transcend, Panasonic
V1.0, V1.1	512 MB	SanDisk, Transcend, Panasonic
V1.0, V1.1	1 GB	SanDisk, Transcend, Panasonic
V2.0 SDHC CLASS 4	4 GB	
V2.0 SDHC CLASS 6	4 GB	SanDisk, Transcend, Panasonic
V1.0, V1.1	microSD 128 MB	Transcend, Panasonic
V1.0, V1.1	microSD 256 MB	Transcend, Panasonic
V1.0, V1.1	microSD 512 MB	Panasonic

V1.0, V1.1	microSD 1 GB	Transcend, Panasonic
V2.0 SDHC CLASS 4	microSD 4 GB	Panasonic
V2.0 SDHC CLASS 6	microSD 4 GB	Transcend
V1.0, V1.1	miniSD 128 MB	Transcend, Panasonic
V1.0, V1.1	miniSD 256 MB	Transcend, Panasonic
V1.0, V1.1	miniSD 512 MB	Transcend, Panasonic
V1.0, V1.1	miniSD 1 GB	Transcend, Panasonic
V2.0 SDHC CLASS 4	miniSD 4 GB	Transcend
V2.0 SDHC CLASS 6	miniSD 4 GB	
<ul style="list-style-type: none"> - The DOS FAT file system is supported for the SD card. - Folders/files stored in the SD card should be in the 8.3 filename format. - The miniSD/microSD card adapter is required for SD card reader. 		

2. ELECTRONICS

2.1 Summary of Board Connectors

Main board

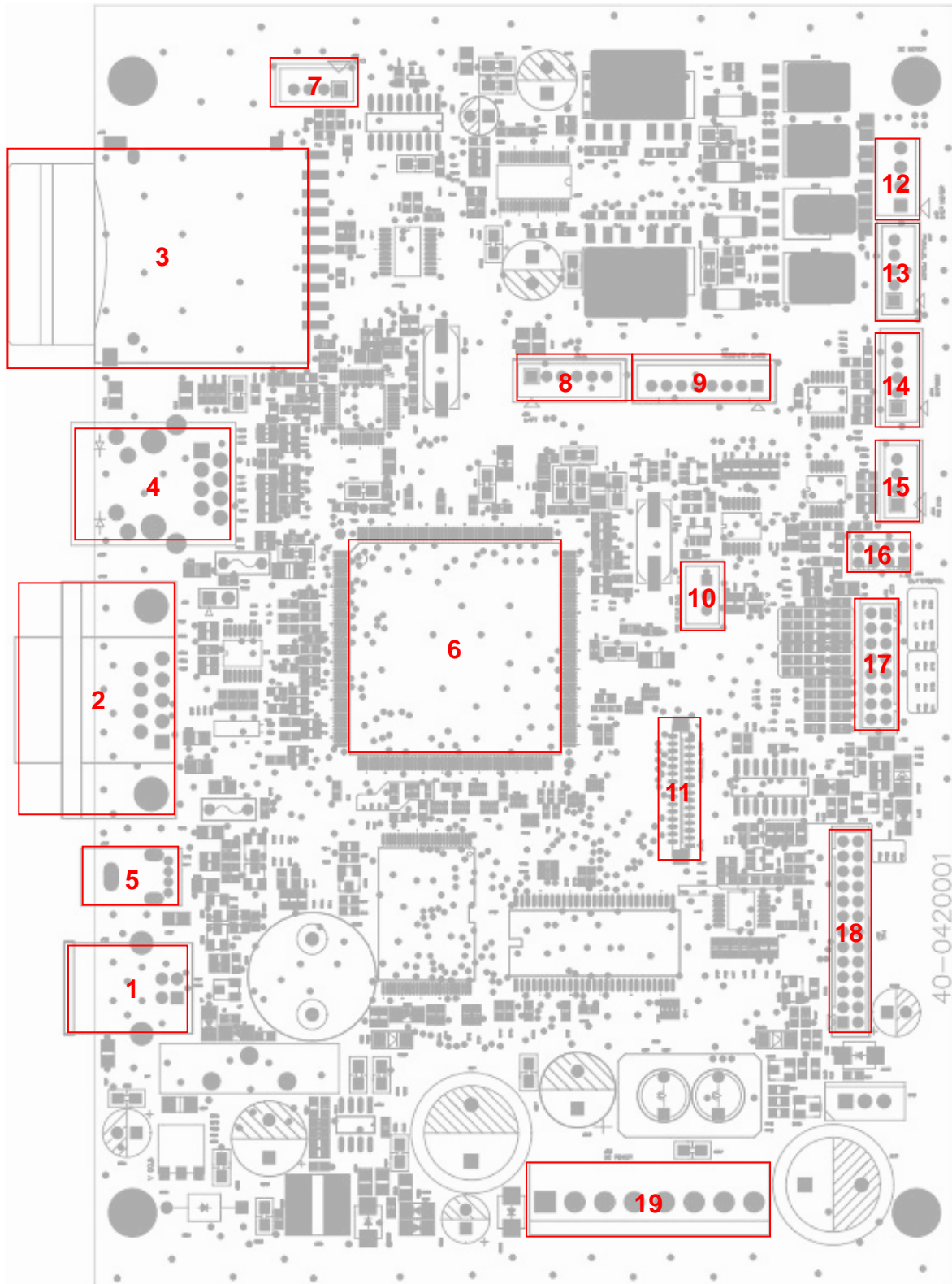

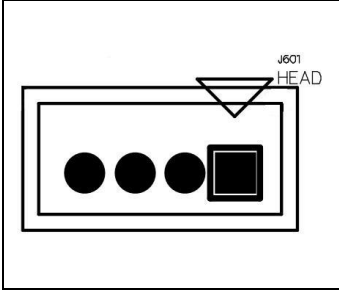
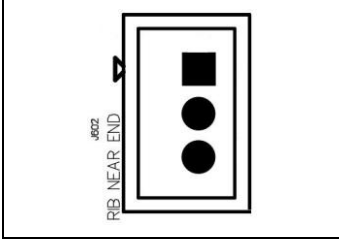
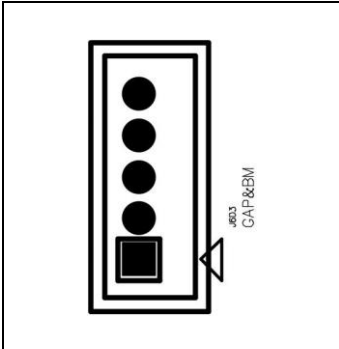
Connector	Description																		
1	USB connector																		
2	RS-232C connector																		
3	SD card slot																		
4	Ethernet RJ-45 connector (Option)																		
5	USB host connector (Option)																		
6	Micro processor																		
7	Head open sensor connector																		
	 <table border="1"> <thead> <tr> <th>Pin</th> <th>Description</th> <th>Voltage</th> </tr> </thead> <tbody> <tr> <td>1</td> <td>Head open sensor emitter power pin</td> <td>1.2~1.4V</td> </tr> <tr> <td>2</td> <td>GND</td> <td>0V</td> </tr> <tr> <td>3</td> <td>Head open sensor receiver</td> <td>0V: Head close 3.3V: Head open</td> </tr> <tr> <td>4</td> <td>GND</td> <td>0V</td> </tr> </tbody> </table>	Pin	Description	Voltage	1	Head open sensor emitter power pin	1.2~1.4V	2	GND	0V	3	Head open sensor receiver	0V: Head close 3.3V: Head open	4	GND	0V			
	Pin	Description	Voltage																
	1	Head open sensor emitter power pin	1.2~1.4V																
	2	GND	0V																
3	Head open sensor receiver	0V: Head close 3.3V: Head open																	
4	GND	0V																	
8	RFID module connector																		
9	Recovery connector																		
10	Ribbon near end sensor connector																		
	 <table border="1"> <thead> <tr> <th>Pin</th> <th>Description</th> <th>Voltage</th> </tr> </thead> <tbody> <tr> <td>1</td> <td>GND</td> <td>0V</td> </tr> <tr> <td>2</td> <td>Encoder signal</td> <td>3.3V</td> </tr> <tr> <td>3</td> <td>Power</td> <td>3.3V</td> </tr> </tbody> </table>	Pin	Description	Voltage	1	GND	0V	2	Encoder signal	3.3V	3	Power	3.3V						
	Pin	Description	Voltage																
	1	GND	0V																
2	Encoder signal	3.3V																	
3	Power	3.3V																	
11	Centronics soft cable connector (Option)																		
12	Stepping motor connector																		
13	Centronics power connector (Option)																		
14	Gap sensor connector																		
	 <table border="1"> <thead> <tr> <th>Pin</th> <th>Description</th> <th>Voltage</th> </tr> </thead> <tbody> <tr> <td>1</td> <td>Power</td> <td>5V</td> </tr> <tr> <td>2</td> <td>Gap sensor emitter</td> <td>4.0~4.1V: Emitter on 4.3~4.4V: Emitter off</td> </tr> <tr> <td>3</td> <td>Black mark sensor emitter</td> <td>4.0~4.1V: Emitter on 4.3~4.4V: Emitter off</td> </tr> <tr> <td>4</td> <td>Gap and black mark sensor receiver</td> <td>A/D: 0~3.3V</td> </tr> <tr> <td>5</td> <td>GND</td> <td>0V</td> </tr> </tbody> </table>	Pin	Description	Voltage	1	Power	5V	2	Gap sensor emitter	4.0~4.1V: Emitter on 4.3~4.4V: Emitter off	3	Black mark sensor emitter	4.0~4.1V: Emitter on 4.3~4.4V: Emitter off	4	Gap and black mark sensor receiver	A/D: 0~3.3V	5	GND	0V
	Pin	Description	Voltage																
	1	Power	5V																
	2	Gap sensor emitter	4.0~4.1V: Emitter on 4.3~4.4V: Emitter off																
	3	Black mark sensor emitter	4.0~4.1V: Emitter on 4.3~4.4V: Emitter off																
4	Gap and black mark sensor receiver	A/D: 0~3.3V																	
5	GND	0V																	
15	Ribbon sensor connector																		

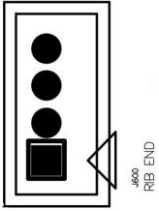
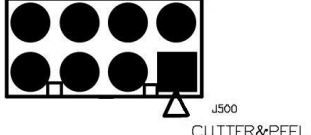
		<table border="1"> <thead> <tr> <th>Pin</th> <th>Description</th> <th>Voltage</th> </tr> </thead> <tbody> <tr> <td>1</td> <td>Ribbon sensor receiver</td> <td>A/D: 0~3.3V</td> </tr> <tr> <td>2</td> <td>Ribbon sensor emitter power pin</td> <td>5V</td> </tr> <tr> <td>3</td> <td>GND</td> <td>0V</td> </tr> <tr> <td>4</td> <td>Ribbon sensor emitter</td> <td>4.0~4.1V: Emitter on 4.3~4.4V: Emitter off</td> </tr> </tbody> </table>	Pin	Description	Voltage	1	Ribbon sensor receiver	A/D: 0~3.3V	2	Ribbon sensor emitter power pin	5V	3	GND	0V	4	Ribbon sensor emitter	4.0~4.1V: Emitter on 4.3~4.4V: Emitter off													
Pin	Description	Voltage																												
1	Ribbon sensor receiver	A/D: 0~3.3V																												
2	Ribbon sensor emitter power pin	5V																												
3	GND	0V																												
4	Ribbon sensor emitter	4.0~4.1V: Emitter on 4.3~4.4V: Emitter off																												
<p>16</p>	<p>Cutter/peel-off sensor connector</p> 	<table border="1"> <thead> <tr> <th>Pin</th> <th>Description</th> <th>Voltage</th> </tr> </thead> <tbody> <tr> <td>1</td> <td>GND</td> <td>0V</td> </tr> <tr> <td>2</td> <td>Cutter power</td> <td>24V</td> </tr> <tr> <td>3</td> <td>Peel sensor emitter</td> <td>4.0~4.1V: Emitter on 4.3~4.4V: Emitter off</td> </tr> <tr> <td>4</td> <td>Logic power</td> <td>5V</td> </tr> <tr> <td>5</td> <td>Cutter position sensor switch</td> <td>0V: Cutter stop 3.3V: Cutter work</td> </tr> <tr> <td>6</td> <td>Peel sensor receiver</td> <td>A/D: 0~3.3V</td> </tr> <tr> <td>7</td> <td>Cutter enable</td> <td>0V: Cutter work 5V: Cutter stop</td> </tr> <tr> <td>8</td> <td>Cutter direction</td> <td>0V: Cutter positive cut 5V: Cutter negative cut</td> </tr> </tbody> </table>	Pin	Description	Voltage	1	GND	0V	2	Cutter power	24V	3	Peel sensor emitter	4.0~4.1V: Emitter on 4.3~4.4V: Emitter off	4	Logic power	5V	5	Cutter position sensor switch	0V: Cutter stop 3.3V: Cutter work	6	Peel sensor receiver	A/D: 0~3.3V	7	Cutter enable	0V: Cutter work 5V: Cutter stop	8	Cutter direction	0V: Cutter positive cut 5V: Cutter negative cut	
Pin	Description	Voltage																												
1	GND	0V																												
2	Cutter power	24V																												
3	Peel sensor emitter	4.0~4.1V: Emitter on 4.3~4.4V: Emitter off																												
4	Logic power	5V																												
5	Cutter position sensor switch	0V: Cutter stop 3.3V: Cutter work																												
6	Peel sensor receiver	A/D: 0~3.3V																												
7	Cutter enable	0V: Cutter work 5V: Cutter stop																												
8	Cutter direction	0V: Cutter positive cut 5V: Cutter negative cut																												
<p>17</p>	LCD panel connector																													
<p>18</p>	Print head signal connector																													
<p>19</p>	Power supply output (24V DC) connector																													

Centronics-interface board

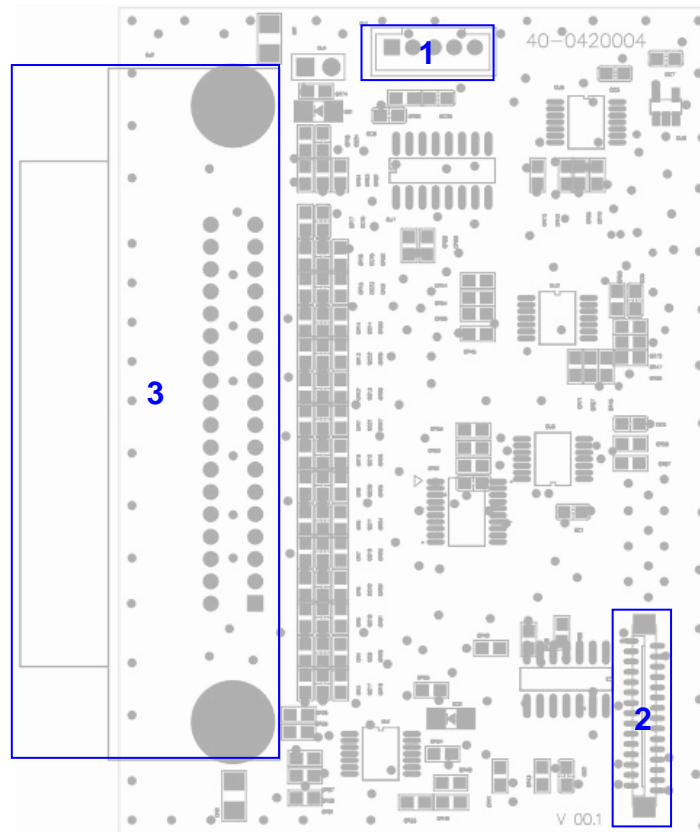

Connector	Description	Remark
1	Centronics soft cable connector	
2	Centronics power connector	
3	Centronics port connector	

2.2 Pin Configuration

RS-232C

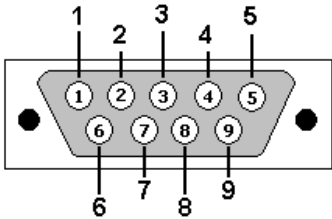
	PIN	CONFIGURATION
		1
	2	TXD
	3	RXD
	4	CTS
	5	GND
	6	RTS
	7	N/C
	8	RTS
	9	N/C

USB

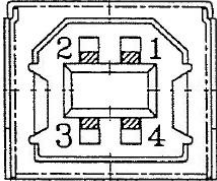
	PIN	CONFIGURATION
		1
	2	D-
	3	D+
	4	GND

Centronics

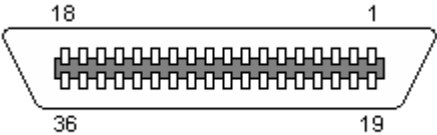
	Pin	SPP Mode	Nibble	In/Out
		1	Strobe	N/A
	2-9	Data 0-7	N/A	In
	10	Ack	N/A	Out
	11	Busy	N/A	Out
	12	Paper Out / End	N/A	Out
	13	Select	N/A	Out
	14	Ground	N/A	GND
	15	No Defined	N/A	N/A
	16-17	Ground	N/A	GND
	18	No Defined	N/A	N/A
	19-30	Ground	N/A	GND
	31	No Defined	N/A	N/A
	32	Error / Fault	N/A	Out
	33-35	Ground	N/A	GND
	36	No Defined	N/A	N/A

Ethernet

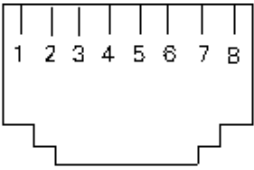
	PIN	CONFIGURATION
	1	Tx+
	2	Tx-
	3	Rx+
	4	N/C
	5	N/C
	6	Rx-
	7	N/C
	8	N/C

3. MECHANISM

3.1 Remove the Electronics Cover

1. Remove three screws on back of the printer.

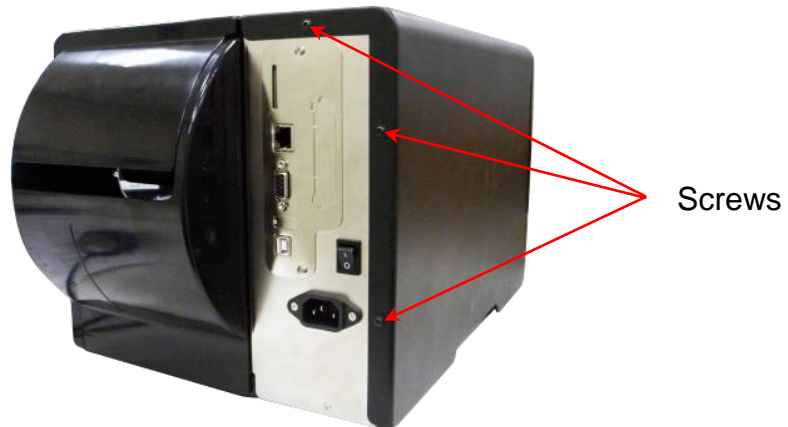

2. Open printer right side cover and remove one screw then close the cover.



3. Remove the electronics cover.

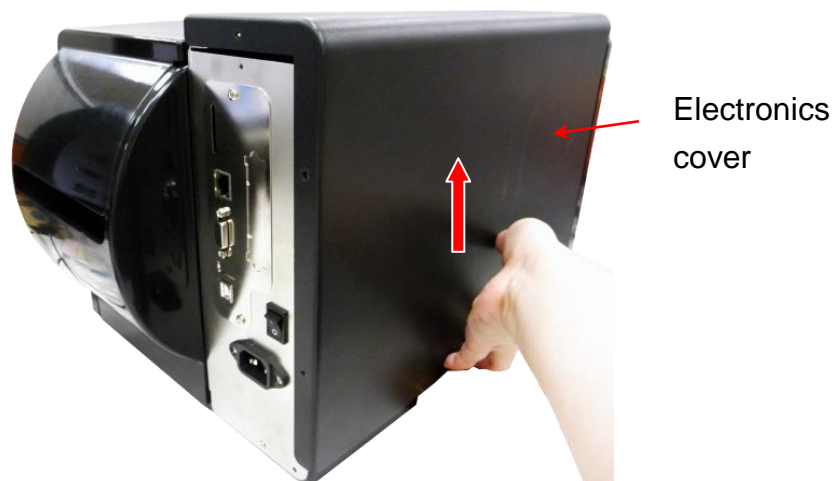

4. Reassemble the parts in the reverse procedures.

3.2 Remove the Right Side Cover

1. Open printer right side cover and remove four screws to remove the printer right side cover.
2. Reassemble the parts in the reverse procedures.



3.3 Replacing the Key/LCD Panel Module

1. Refer to section 3.1 to remove the electronics cover.
2. Disconnect harness from the Key/LCD panel module.
3. Push two tabs to remove/replace the Key/LCD panel module.

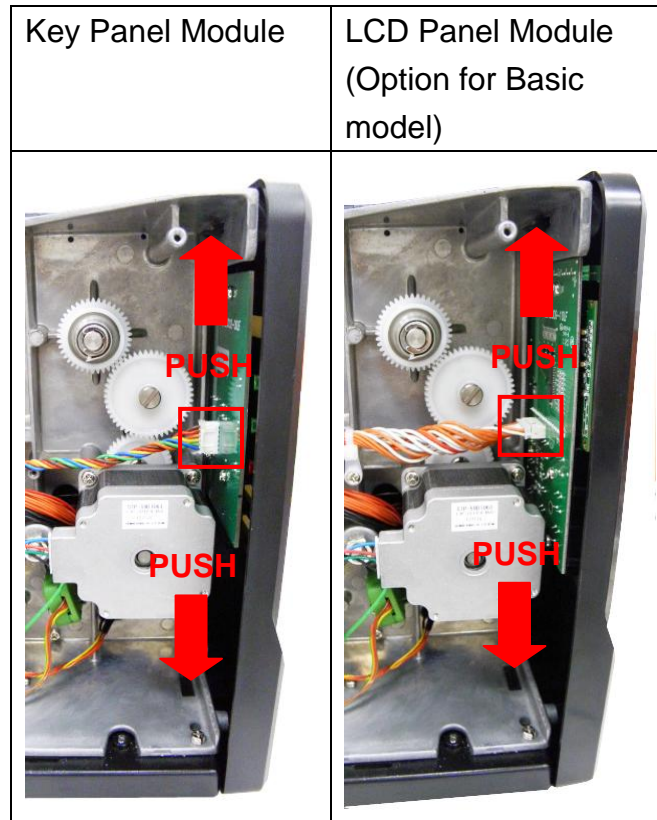

4. Reassemble the parts in the reverse procedures.

3.4 Replacing the Main Board

1. Refer to section 3.1 to remove electronics cover.
2. Remove two screws on the power jack socket then pull out the socket.

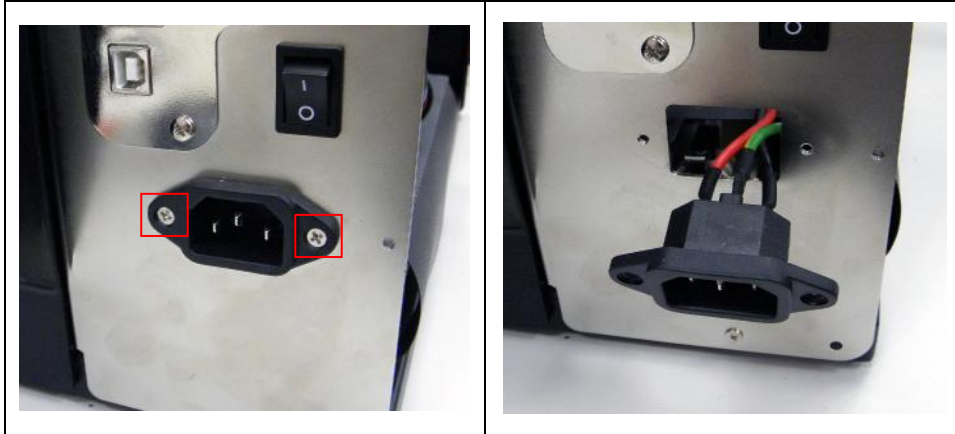

3. Disconnect all connectors from the main board.

Note:

You should press the tab of power supply harness when disconnect the power supply connector.

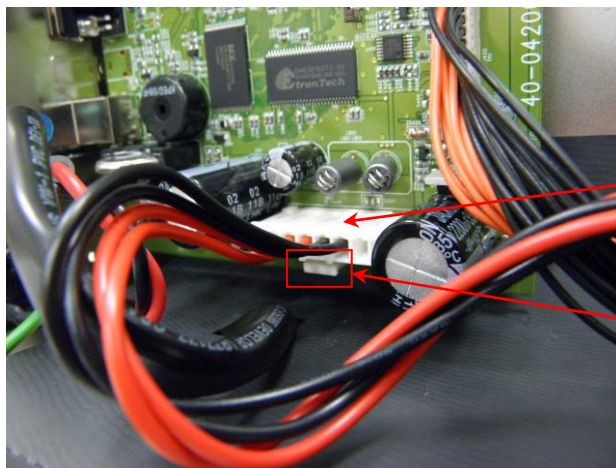

The connector to power supply

The tab of harness

4. Remove four screws on the main board.

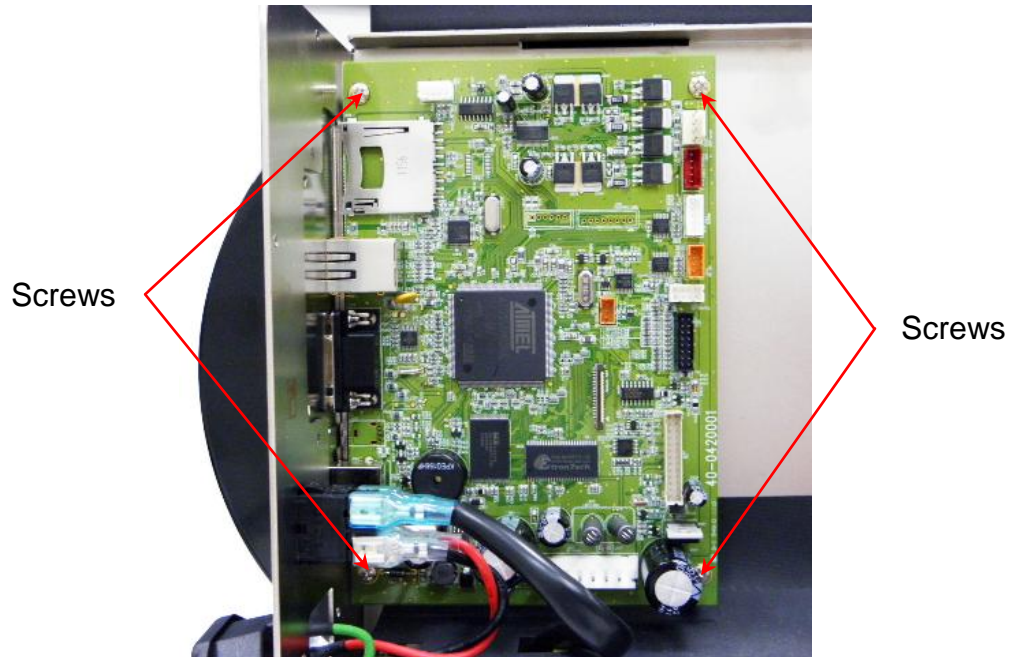

4. Replace the main board.

5. Reassemble the parts in the reverse procedures.

3.5 Replacing the Power Supply Unit

1. Refer to section 3.4 to remove the main board.
2. Disconnect two connectors from the power switch.

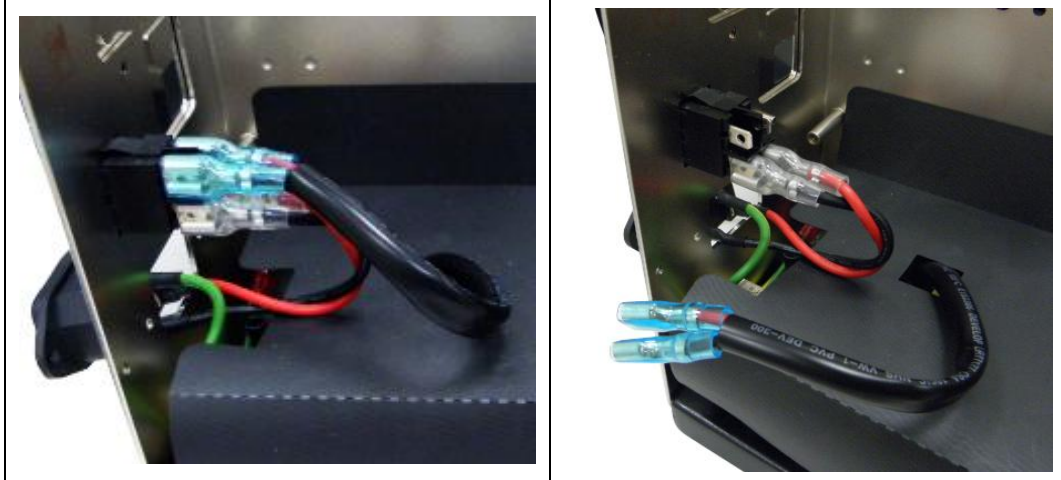

3. Take off the power supply cover (black mylar). Disconnect two connectors and remove four screws on the power supply unit.

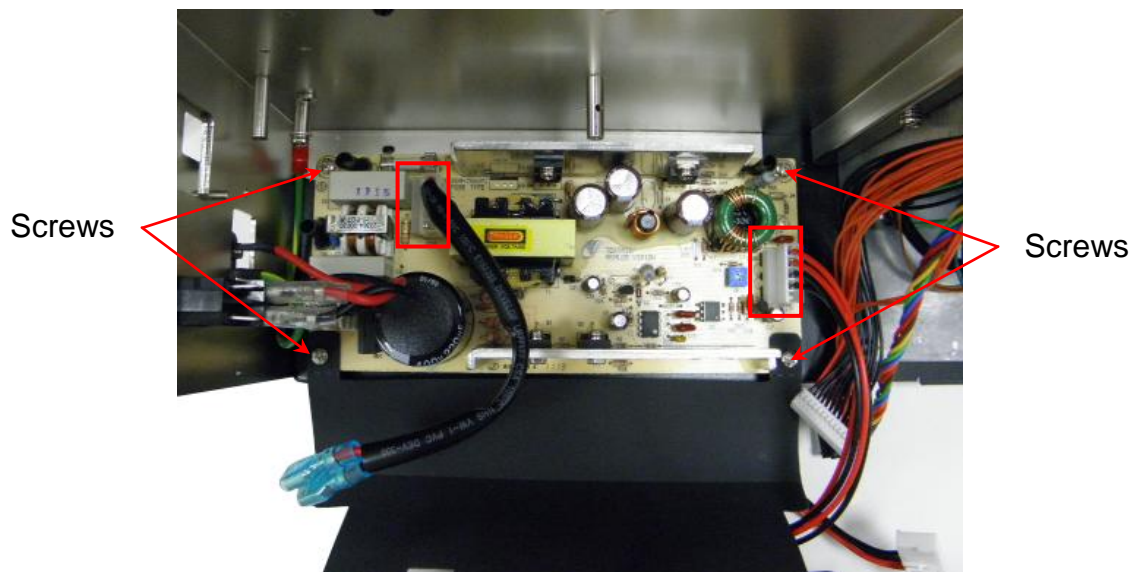

3. Replace the power supply unit.
4. Reassemble the parts in the reverse procedures.

3.6 Replacing the Stepping Motor

1. Refer to section 3.1 to remove the electronics cover.
2. Disconnect the stepping motor connector.

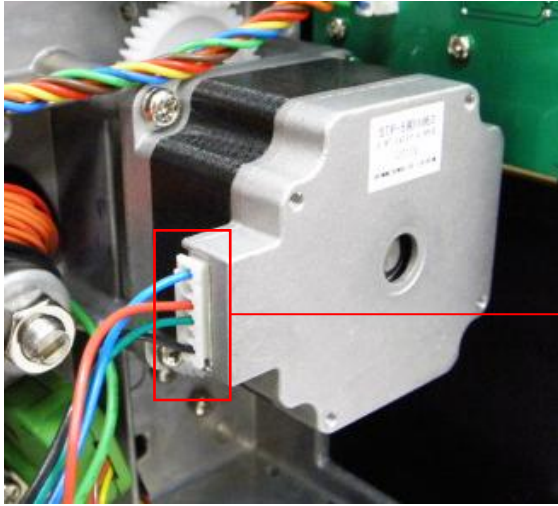

Stepping motor connector

3. Remove three screws on the stepping motor.

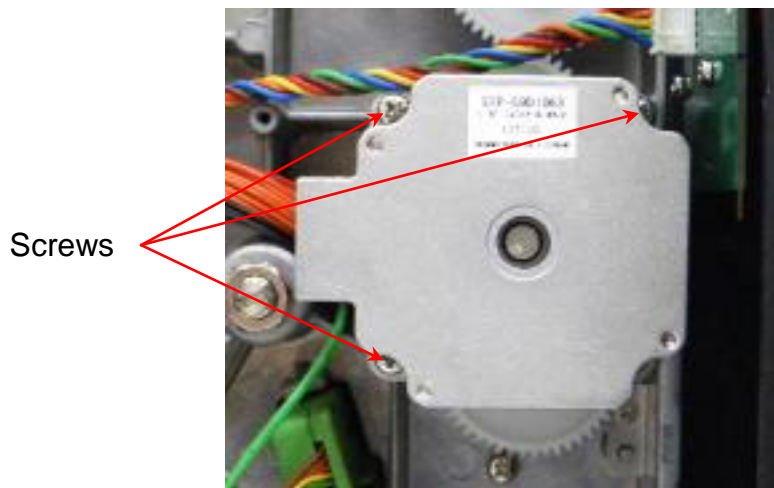

4. Replace the stepping motor.
5. Reassemble the parts in the reverse procedures.

3.7 Replacing the Platen Roller Assembly

1. Open printer right side cover.
2. Disengage the print head lift lever.
3. Remove one screw to remove the lower front cover.

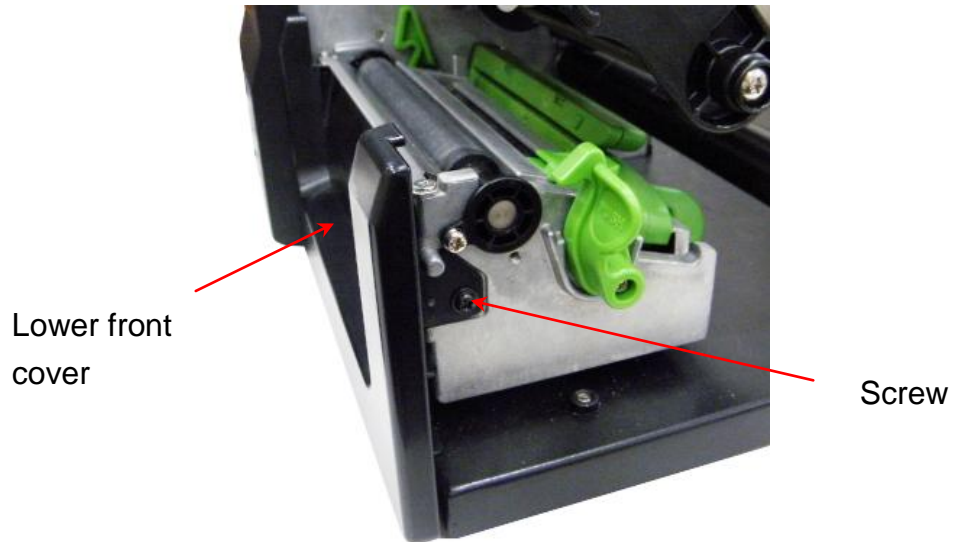

4. Remove one screw on the platen right side bushing.

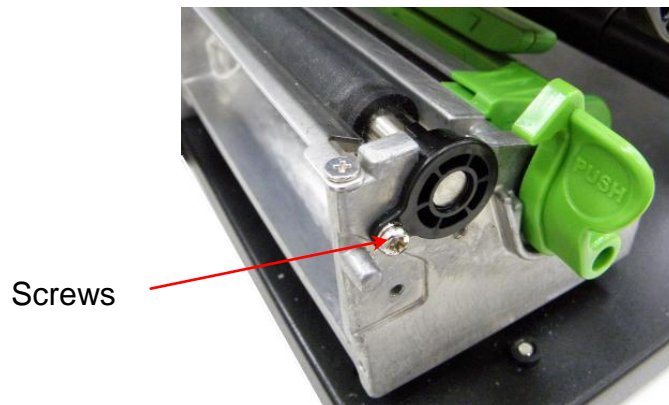

5. Disengage the platen left side bushing tab from the printer.







6. Take out the platen bushing, platen roller assembly and replace a new platen roller assembly.



7. Reassemble the parts in the reverse procedures.

Note:

For regular label	For thick label (Thickness is 0.19 mm)
	
	

3.8 Replacing the Print head ASS'Y

1. Open the printer right side cover.
2. Remove one screw from the mechanism.

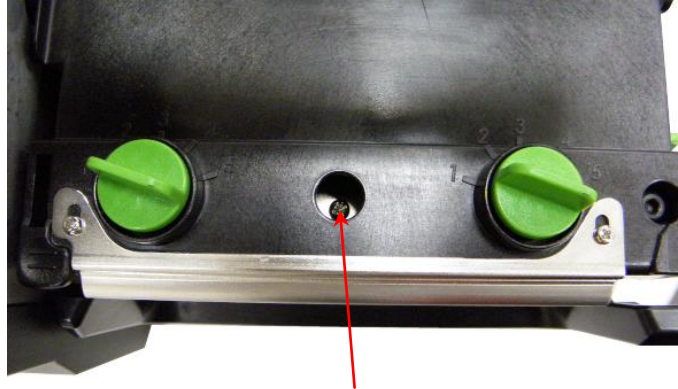

Screws

3. Disengage the print head release lever.
4. Carefully disconnect the print head connector from the print head module.

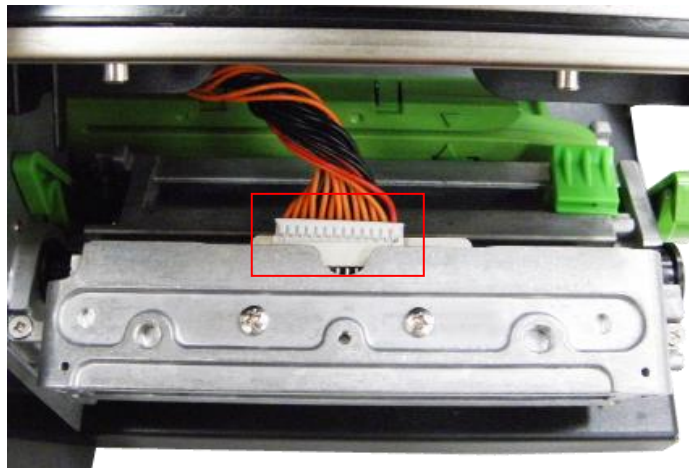

5. Replace the print head module.



Print head module

6. Connect the print head cable and carefully slide assembly into the print mechanism. The holes of print head assembly must align and then insert the tenons of print mechanism.

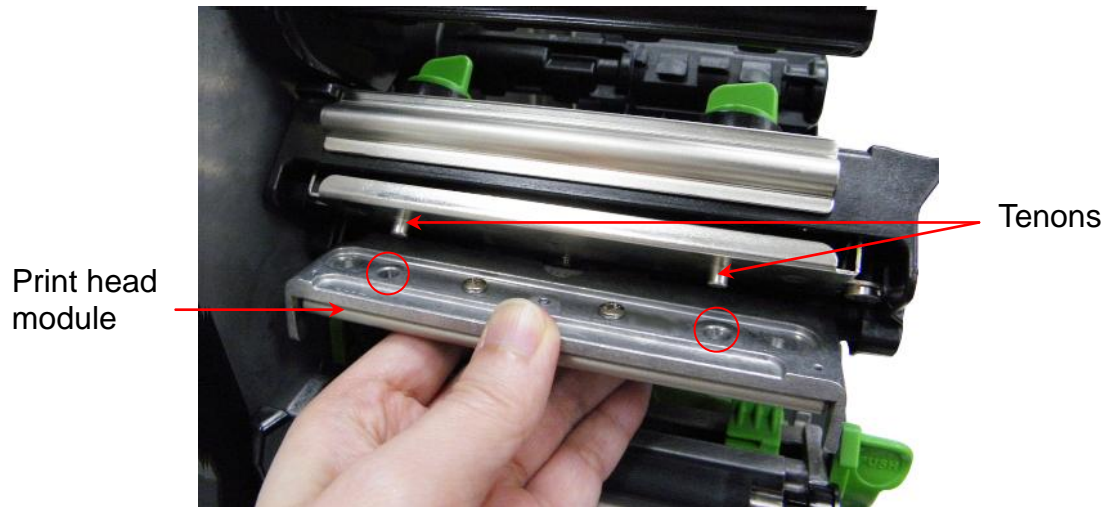

7. Close the print head release lever. Use the new screw to install the new print head module.

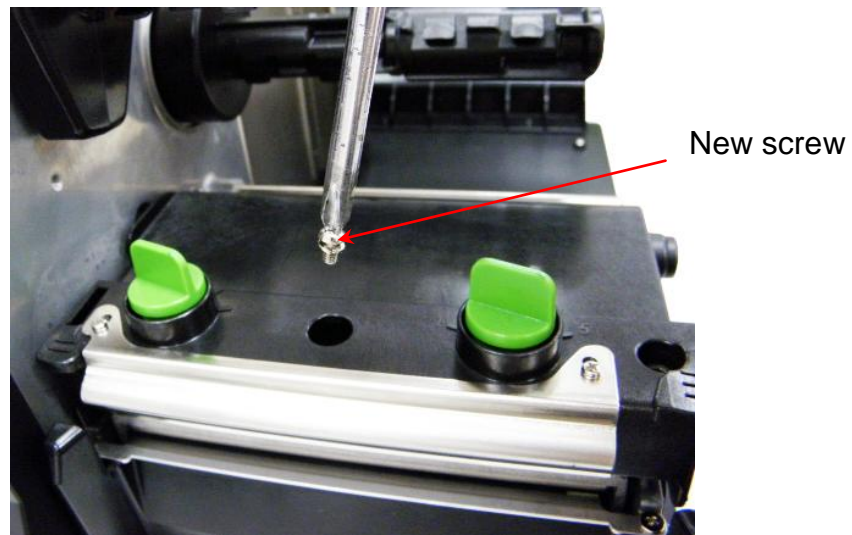

3.9 Replacing the Media Sensor Module

1. Refer to section 3.1 to remove the electronics cover.
2. Disconnect the media sensor module connector from the main board.

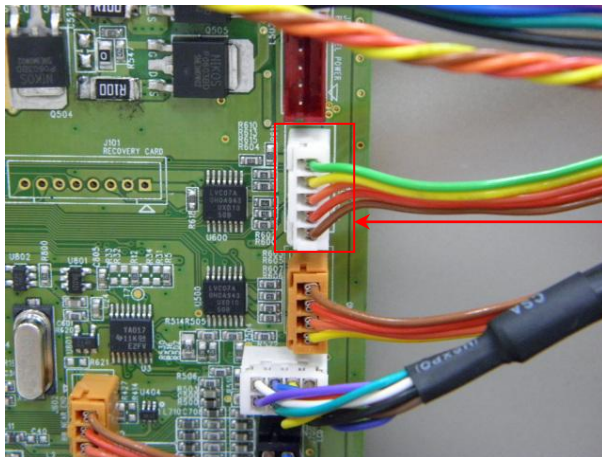

Media sensor module connector

3. At the bottom of the media sensor module, there is a green plastic tab to latch the sensor module to the mechanism. Use a tool to push up the tab then pull out the media sensor module.



6. Replace the media sensor module.

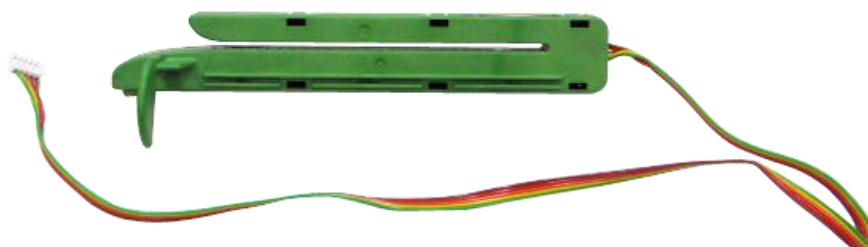

7. Reassemble the parts in the reverse procedures.

3.10 Replacing the Ribbon End Sensor Module

1. Refer to section 3.1 to remove the electronics cover.
2. Disconnect the ribbon end sensor module connector from the main board.

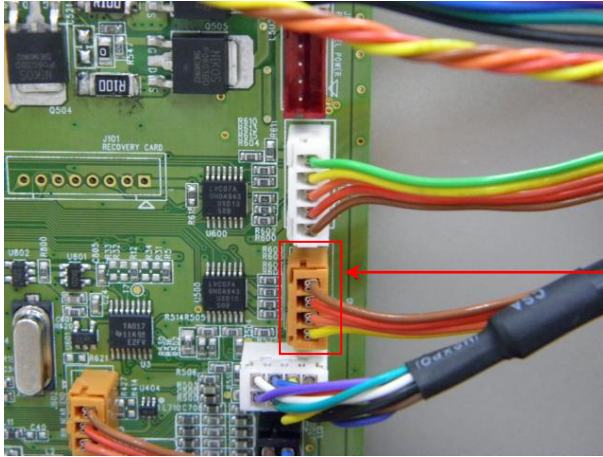

Ribbon end sensor module connector

3. Remove two screws to remove the ribbon end sensor module.

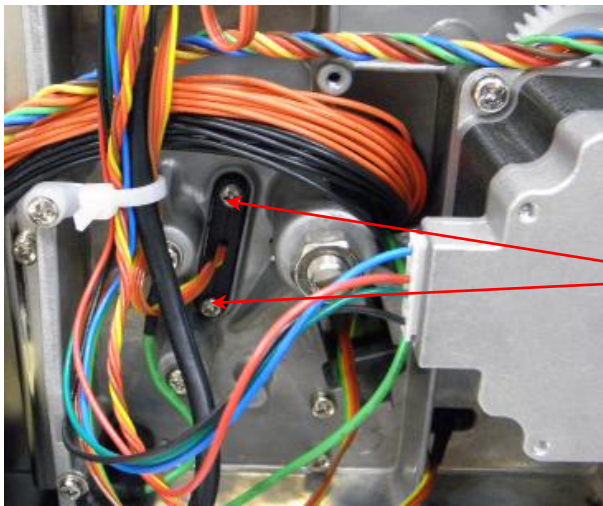

Screws

6. Replace the media sensor module.

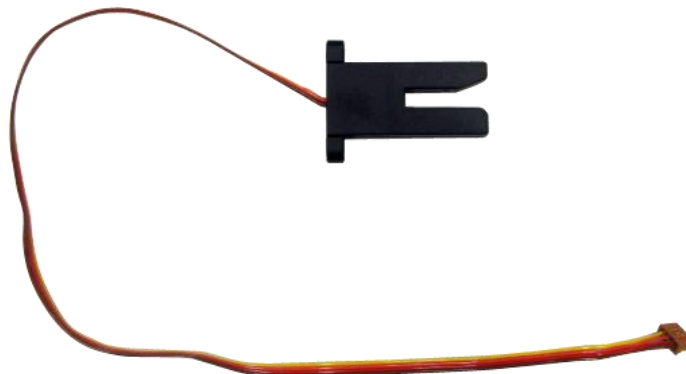

7. Reassemble the parts in the reverse procedures.

3.11 Replacing the Ribbon Encoder Sensor Module

1. Refer to section 3.1 to remove the electronics cover.
2. Disconnect the ribbon encoder sensor module connector from the main board.

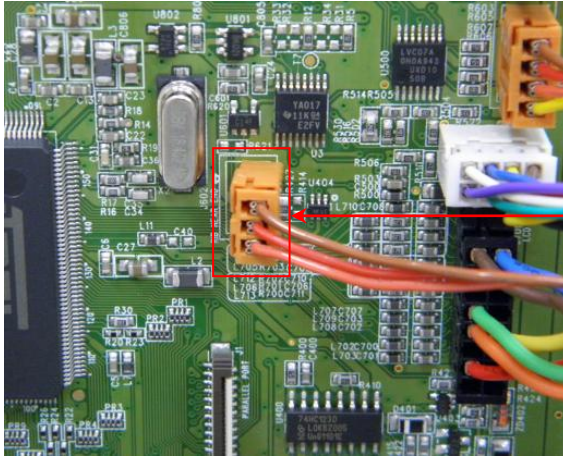

Ribbon encoder sensor module connector

3. Remove one screw that fixing the ribbon supply spindle.

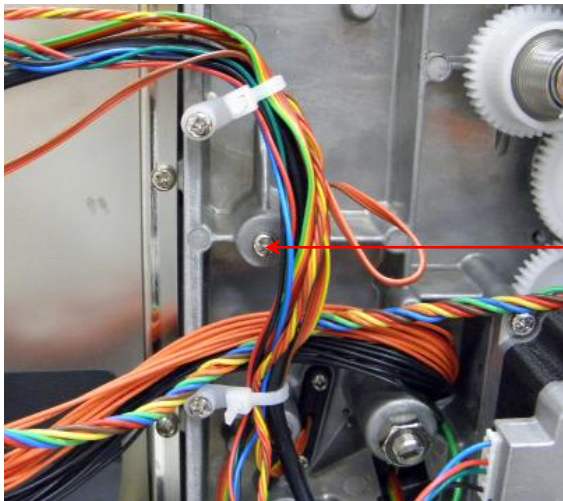

Screw

6. Open the printer right side cover to remove the ribbon supply spindle.



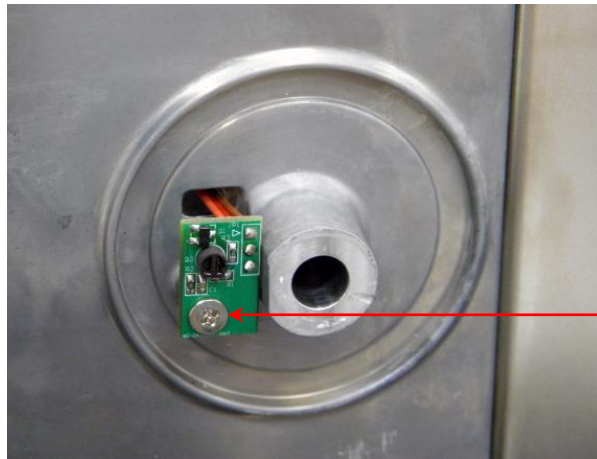

7. Remove one screw to replace the ribbon encoder sensor module.



Screw

8. Reassemble the parts in the reverse procedures.

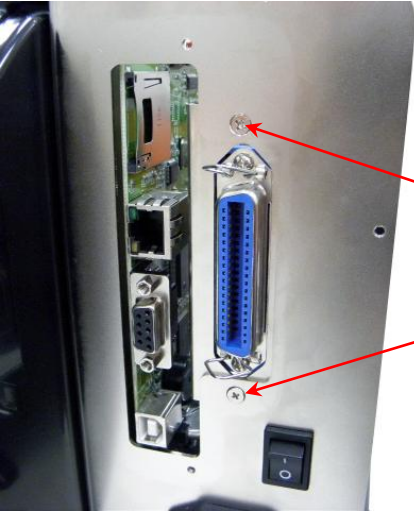
3.12 Centronics Parallel Interface Board Installation (Option)

 A photograph of the rear panel of a printer with the interface cover removed. Two screws are visible, one at the top and one at the bottom of the cover's mounting area. Red arrows point from the text 'Screws' to these two screws.	<ol style="list-style-type: none">1. Refer to section 3.1 to remove the electronics cover.2. Remove two screws to remove the interface cover. <p>Screws</p>
 A close-up photograph of the rear panel showing the Centronics parallel interface board installed. Two screws are being used to secure the board. Red arrows point from the text 'Screws' to these two screws.	<ol style="list-style-type: none">3. Use two screws to fix the Centronics parallel interface board on the rear of printer. <p>Screws</p>
 A photograph of the rear panel showing the interface cover reattached. The cover is now in place, and the two screws are visible, securing it to the panel.	<ol style="list-style-type: none">4. Break the tab at the interface cover to get the parallel interface opening. Then fasten the interface cover back by two screws.

5. Loosen the connector before install the flat cable.

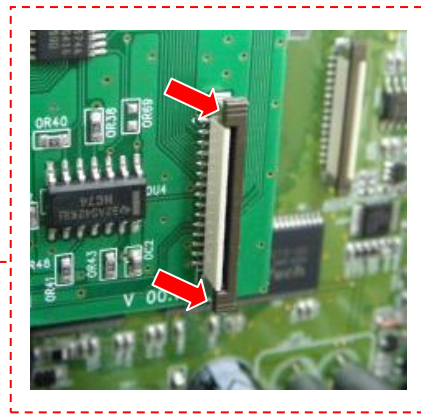
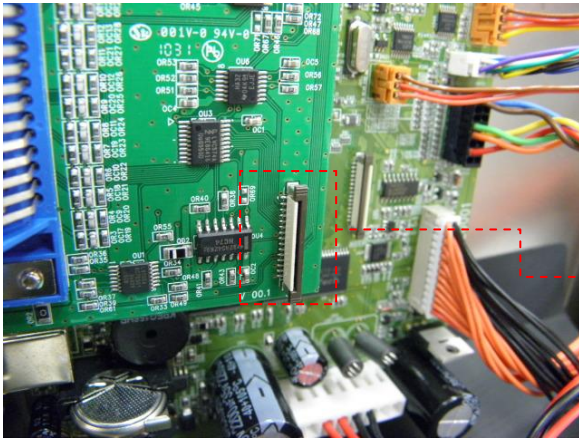

6. Connect the flat cable between the Centronics parallel interface board and the main board.

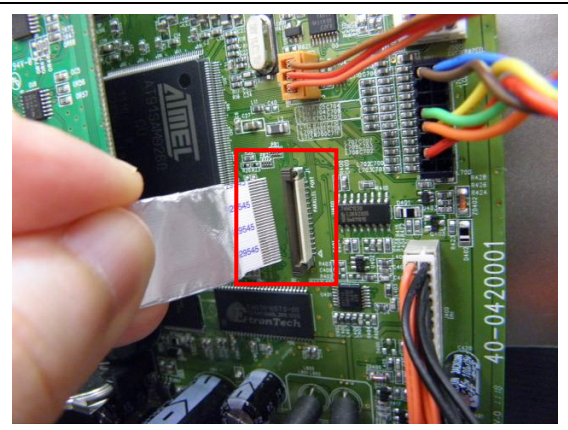
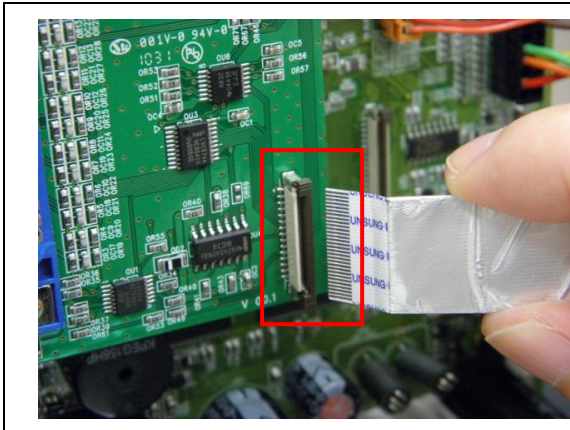

7. Connect the 5-pin cable between the Centronics parallel interface board and main board.

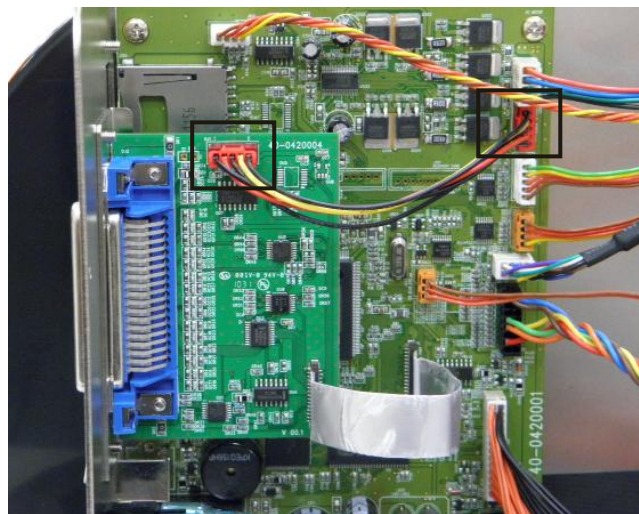

8. Reassemble the parts in the reverse procedures.

3.13 Cutter Module Installation (Option)

1. Open printer right side cover.
2. Remove one screw to remove the lower front cover.

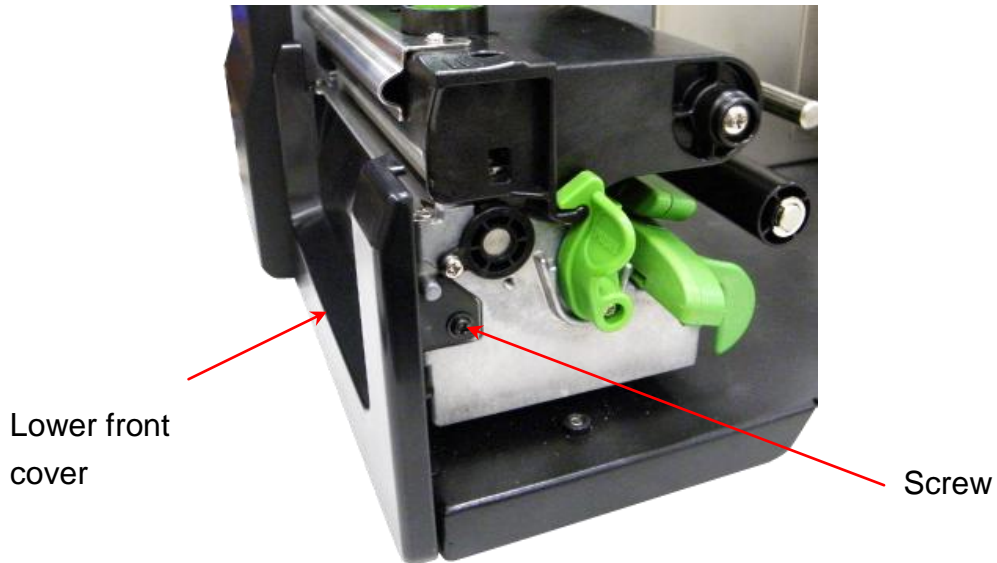

3. Thread the cutter cable through the bottom of lower print mechanism.

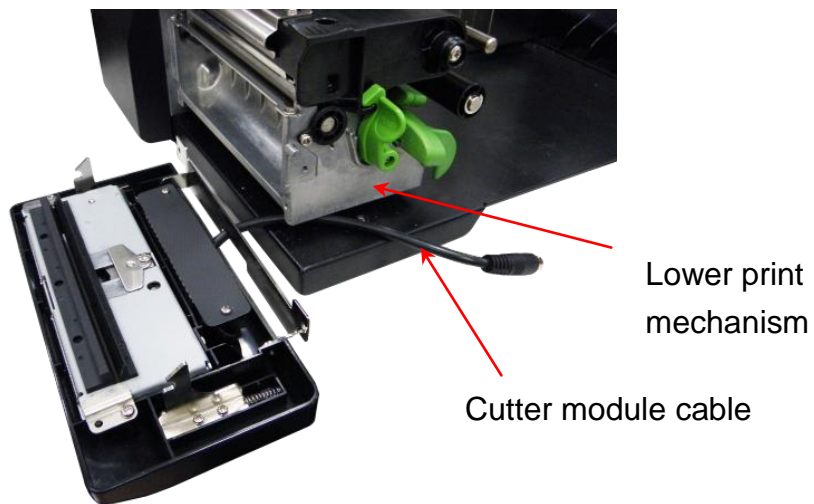

4. Plug the cutter mini DIN cable connector into the cutter/peel-off module cable connector. The triangle mark on the connector must be at the upper side.

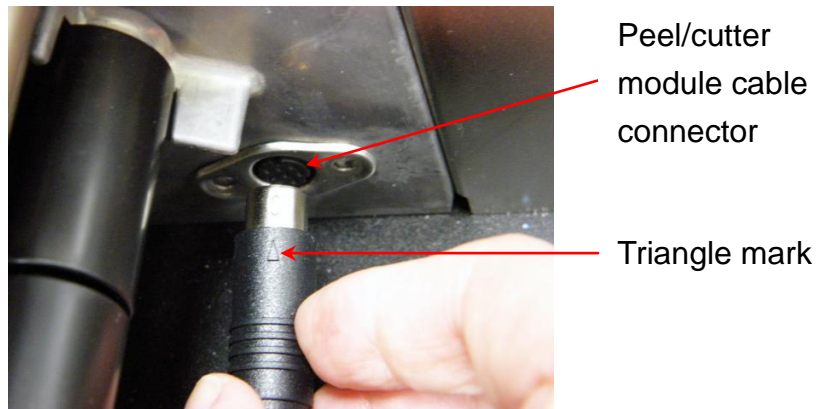

5. Use enclosed two screws to fix the cutter fixing plate onto the lower print mechanism.

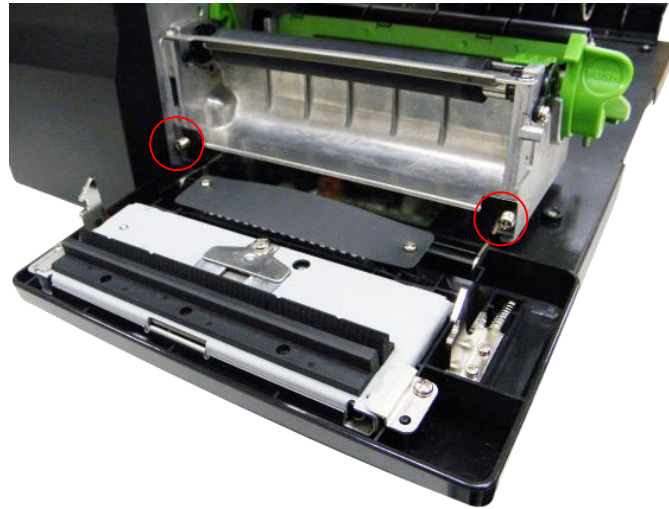

6. Close the cutter cover.

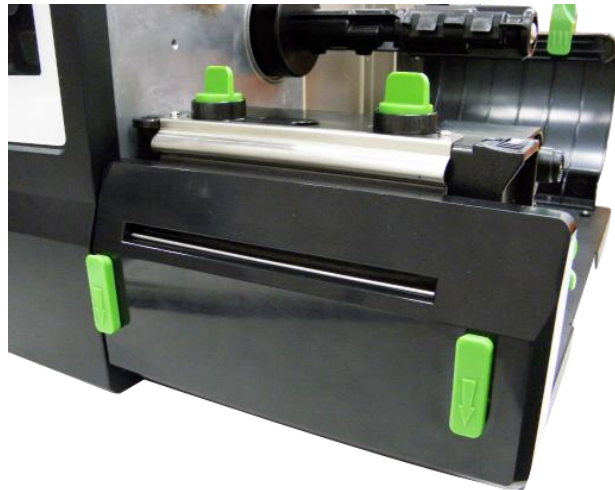

3.14 Peel-off Module Installation (Option)

1. Open printer right side cover.
2. Remove one screw to remove the lower front cover.

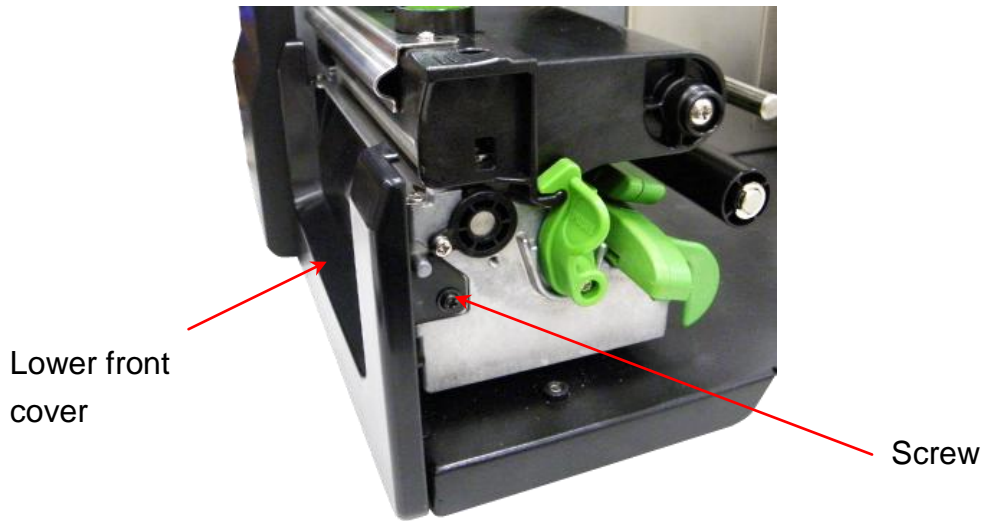

3. Thread the peel-off module cable through the bottom of lower print mechanism.

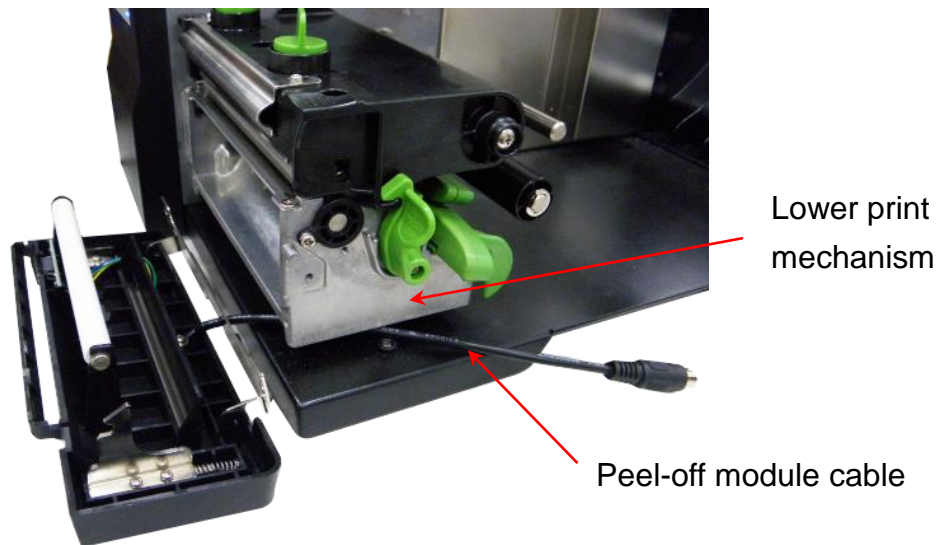

4. Plug the peel-off module mini DIN cable connector into the cutter/peel-off connector. The arrow mark on the connector must be at the upper side.

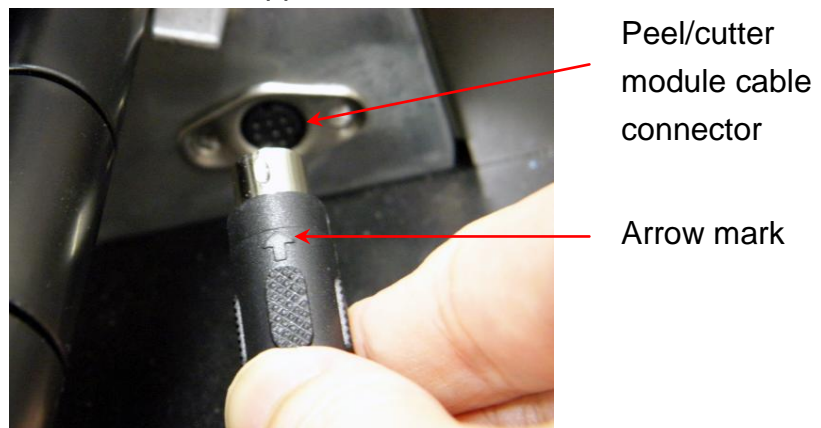

5. Use enclosed two screws to fix the peel-off fixing plate onto the lower print mechanism.

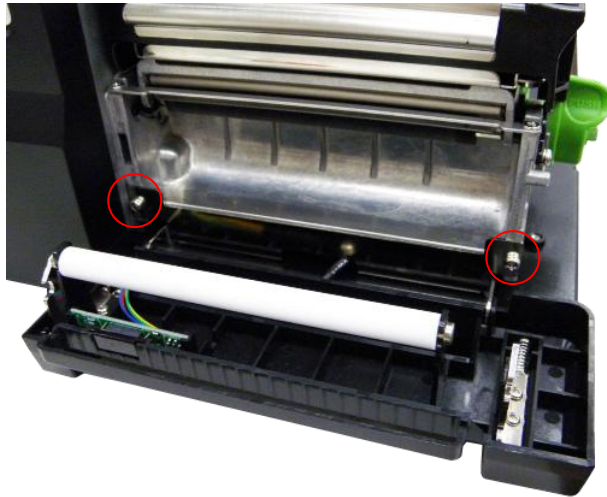

6. Close the peel-off cover.



3.15 Print Engine Module Specification (Option)

Print engine module measurements

-Print engine module

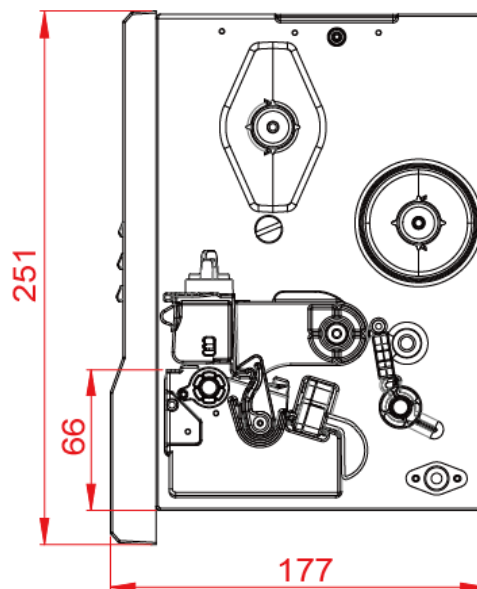
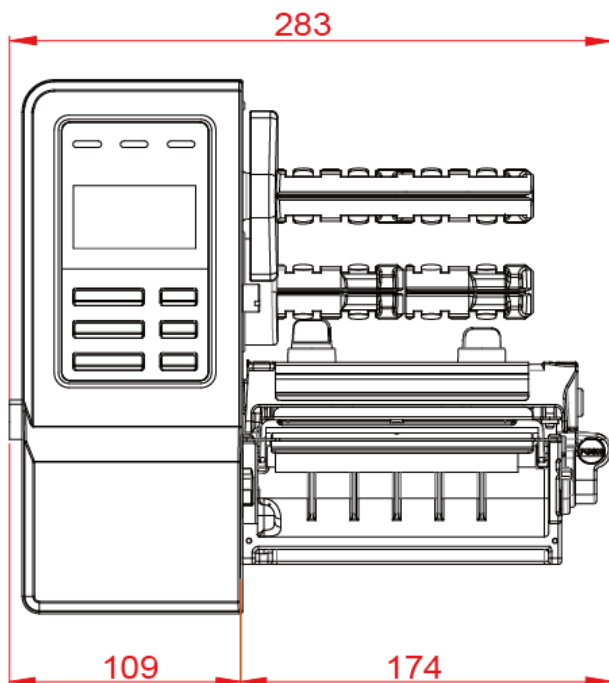

-Print engine module with peel-off

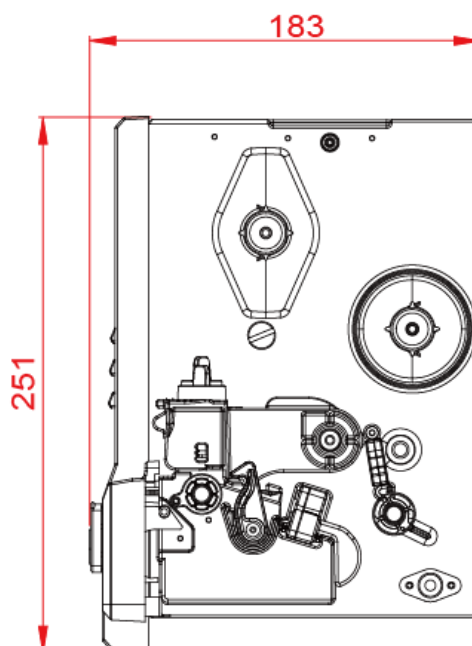
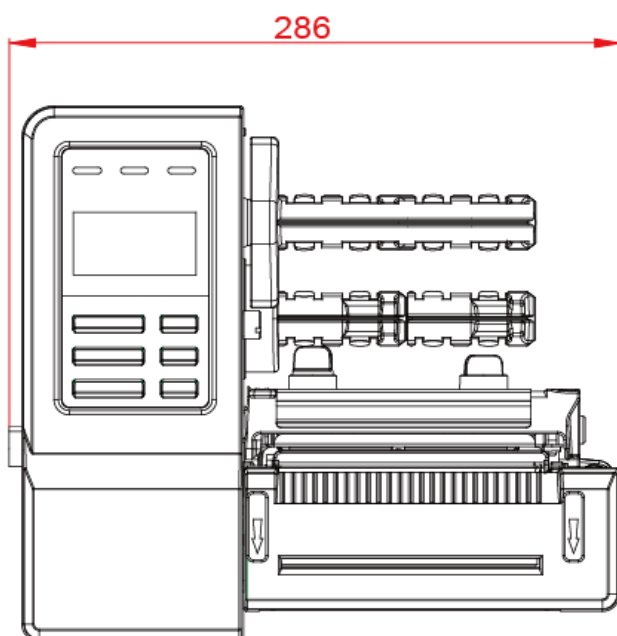

-Print engine module with cutter

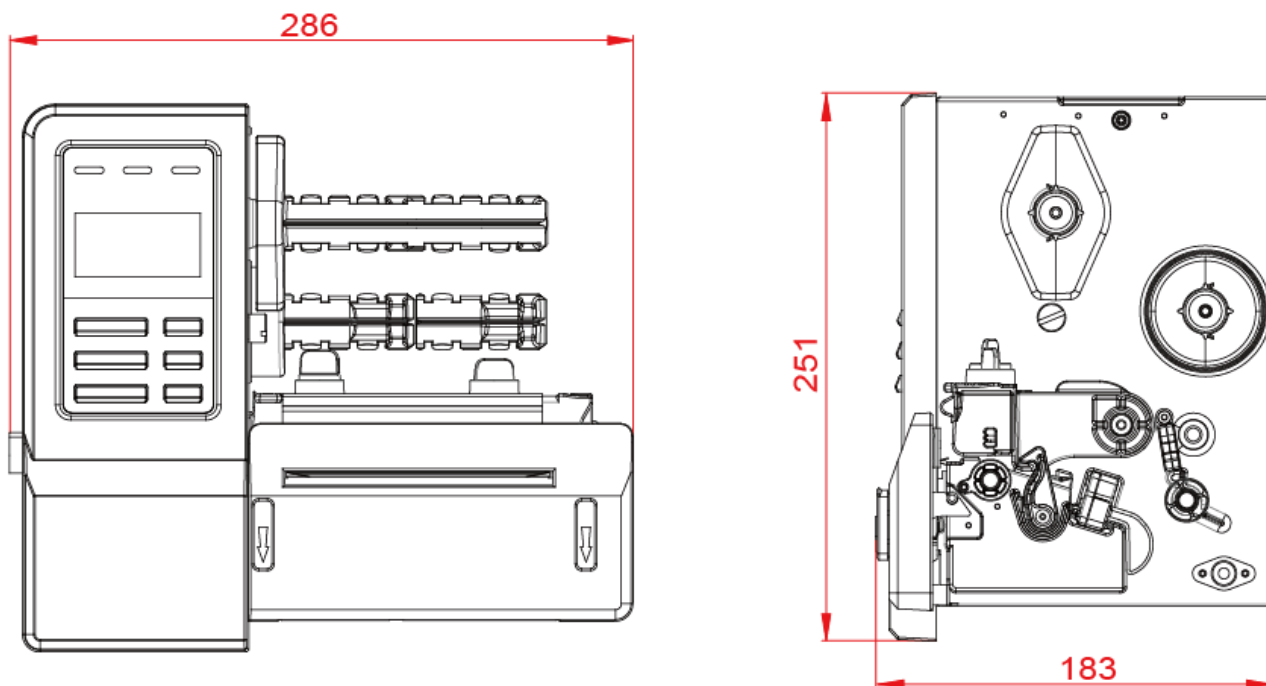

Bottom view

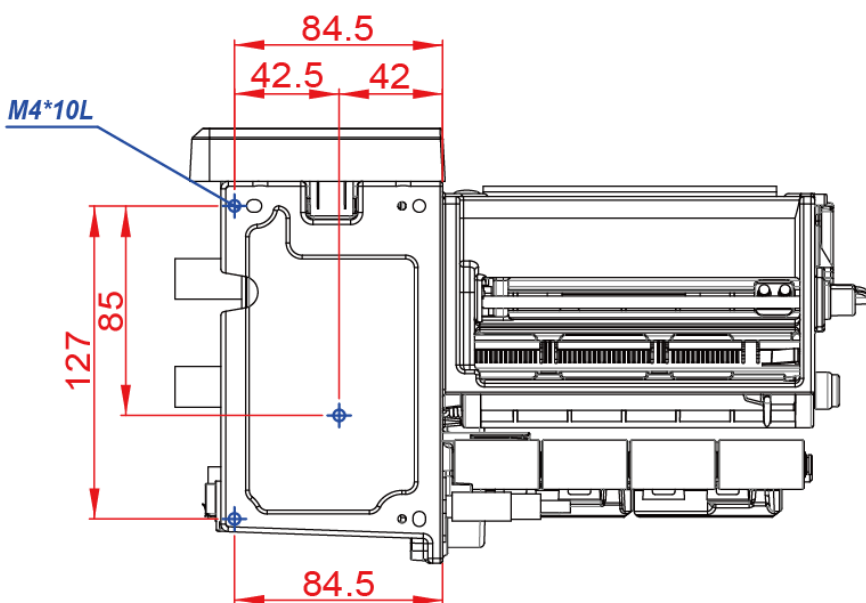

Note:

1. All measurements are in mm.
2. There are 3 fastenings in this print engine module, the fastening location be marked in blue on bottom view drawing, fits with screw M4*10L.

4. TROUBLESHOOTING

4.1 Common Problems

The following guide lists the most common problems that might be encountered when operating this bar code printer. If the printer still does not function after all suggested solutions have been invoked, please contact the Customer Service Department of your purchased reseller or distributor for assistance.

Problem	Possible Cause	Recovery Procedure						
Power indicator does not illuminate	* The power cord is not properly connected.	* Plug the power cord in printer and outlet. * Switch the printer on.						
- The printer status from DiagTool shows " Head Open ". - The LCD shows " Carriage Open ".	* The printer carriage is open.	* Please close the print carriage.						
- The printer status from DiagTool shows " Ribbon End Err. " Or " Ribbon Encoder Err. " - The LCD shows " No Ribbon ".	* Running out of ribbon. * The ribbon is installed incorrectly.	* Supply a new ribbon roll. * Please refer to the steps in user's manual to reinstall the ribbon.						
- The printer status from DiagTool shows " Out of Paper ". - The LCD shows " No Paper ".	* Running out of label. * The label is installed incorrectly. * Gap/black-mark sensor is not calibrated.	* Supply a new label roll. * Please refer to the steps in user's manual to reinstall the label roll. * Calibrate the gap/black-mark sensor.						
- The printer status from DiagTool shows " Paper Jam ". - The LCD shows " Paper Jam ".	* Gap/black-mark sensor is not set properly. * Make sure label size is set properly. * Labels may be stuck inside the printer mechanism.	* Calibrate the gap/black-mark sensor. * Set label size correctly.						
- The LCD shows " Take Label ".	* Peel-off function is enabled.	* If the peel-off module is installed, please remove the label. * If there is no peel-off module in front of the printer, please switch off the printer and install it. * Check if the connector is plugging correctly.						
<table border="1" data-bbox="199 1848 470 1998"> <tr> <td>UP:</td> <td>Fwd.</td> </tr> <tr> <td>DOWN:</td> <td>Rev.</td> </tr> <tr> <td>MENU:</td> <td>Exit</td> </tr> </table>	UP:	Fwd.	DOWN:	Rev.	MENU:	Exit	* Cutter jam. * There is no cutter installed on the printer. * Cutter PCB is damaged.	* If the cutter module is installed, please press UP or DOWN key to rotate the cutter up or down to make the knife back to the right position. * Remove the label. * Make sure the thickness of label is less than 0.254 mm (10mil) * Replace a cutter PCB.
UP:	Fwd.							
DOWN:	Rev.							
MENU:	Exit							

<p>Not Printing</p>	<p>* Cable is not well connected to serial or USB interface or parallel port. * The serial port cable pin configuration is not pin to pin connected.</p>	<p>* Re-connect cable to interface. * If using serial cable, - Please replace the cable with pin to pin connected. - Check the baud rate setting. The default baud rate setting of printer is 9600,n,8,1. * If using the Ethernet cable, - Check if the Ethernet RJ-45 connector green LED is lit on. - Check if the Ethernet RJ-45 connector amber LED is blinking. - Check if the printer gets the IP address when using DHCP mode. - Check if the IP address is correct when using the static IP address. - Wait a few seconds let the printer get the communication with the server then check the IP address setting again. * Chang a new cable. * Ribbon and media are not compatible. * Verify the ribbon-inked side. * Reload the ribbon again. * Clean the printhead. * The print density setting is incorrect. * Printhead's harness connector is not well connected with printhead. Turn off the printer and plug the connector again. * Check if the stepping motor is plugging in the right connector. * Check your program if there is a command PRINT at the end of the file and there must have CRLF at the end of each command line.</p>
<p>Memory full (FLASH / DRAM)</p>	<p>* The space of FLASH/DRAM is full.</p>	<p>* Delete unused files in the FLASH/DRAM. * The max. numbers of file of DRAM is 256 files. * The max. user addressable memory space of DRAM is 256 KB. * The max. numbers of file of FLASH is 256 files. * The max. user addressable memory space of FLASH is 2560KB.</p>
<p>SD card is unable to use</p>	<p>* SD card is damaged. * SD card doesn't insert correctly. * Use the non-approved SD card manufacturer.</p>	<p>* Use the supported capacity SD card. * Insert the SD card again. * The supported SD card spec and the approved SD card manufacturers, please refer to section 1.1</p>

<p align="center">Poor Print Quality</p>	<ul style="list-style-type: none"> * Ribbon and media is loaded incorrectly * Dust or adhesive accumulation on the print head. * Print density is not set properly. * Print head element is damaged. * Ribbon and media are incompatible. * The print head pressure is not set properly. 	<ul style="list-style-type: none"> * Reload the supply. * Clean the print head. * Clean the platen roller. * Adjust the print density and print speed. * Run printer self-test and check the print head test pattern if there is dot missing in the pattern. * Change proper ribbon or proper label media. * Adjust the print head pressure adjustment knob. <ul style="list-style-type: none"> - If the left side printout is too light, please adjust the left side pressure adjustment knob to the higher index (higher pressure). If the pressure adjustment knob has been adjust to index "5" and the poor print quality is still at the left side of the printout, please adjust the pressure adjustment knob to index "1" and use the Z-axis adjustment knob to fine tune the pressure. - If the right side printout is too light, please adjust the right side pressure adjustment knob to the higher index (higher pressure) to improve the print quality. * If the label thickness is more than 0.22 mm, the print quality might be not good enough, please adjust the heater line adjustment screw counter clockwise to get the best print quality. * The release lever does not latch the print head properly.
<p>LCD panel is dark and keys are not working</p>	<ul style="list-style-type: none"> * The cable between main PCB and LCD panel is loose. 	<ul style="list-style-type: none"> * Check if the cable between main PCB and LCD is secured or not.
<p>LCD panel is dark but the LEDs are light</p>	<ul style="list-style-type: none"> * The printer initialization is unsuccessful. 	<ul style="list-style-type: none"> * Turn OFF and ON the printer again. * Initialize the printer.
<p>LCD panel is dark and LEDs are lit on, but the label is feeding forward</p>	<ul style="list-style-type: none"> * The LCD panel harness connector is loose. 	<ul style="list-style-type: none"> * The LCD panel harness connector is plugged upside down.
<p>Peel sensor is not working</p>	<ul style="list-style-type: none"> * The connector is loose. 	<ul style="list-style-type: none"> * Plug the connect cable correctly.
<p>Ribbon encoder sensor doesn't work</p>	<ul style="list-style-type: none"> * The ribbon encoder sensor connector is loose. 	<ul style="list-style-type: none"> * Fasten the connector.
<p>Ribbon end sensor doesn't work</p>	<ul style="list-style-type: none"> * The connector is loose. * The ribbon sensor hole is covered with dust. 	<ul style="list-style-type: none"> * Check the connector. * Clear the dust in the sensor hole by the blower.
<p>Cutter is not working</p>	<ul style="list-style-type: none"> * The connector is loose. 	<ul style="list-style-type: none"> * Plug in the connect cable correctly.
<p>Label feeding is not stable (skew) when printing</p>	<ul style="list-style-type: none"> * The media guide does not touch the edge of the media. 	<ul style="list-style-type: none"> * If the label is moving to the right side, please move the label guide to left. * If the label is moving to the left side, please move the label guide to right.

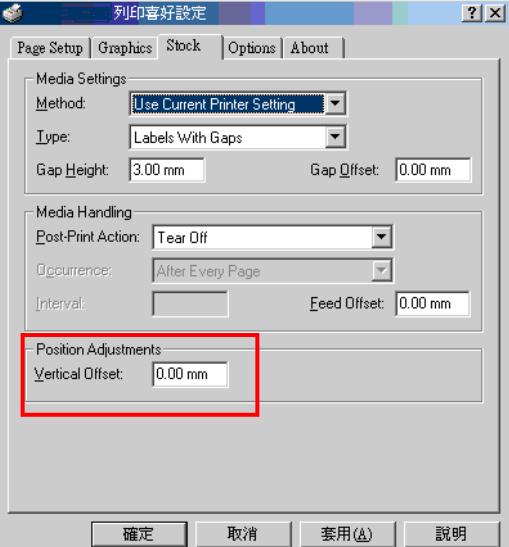
<p>Skip labels when printing</p>	<ul style="list-style-type: none"> * Label size is not specified properly. * Sensor sensitivity is not set properly. * The media sensor is covered with dust. 	<ul style="list-style-type: none"> * Check if label size is setup correctly. * Calibrate the sensor by Auto Gap or Manual Gap options. * Clear the GAP/Black-mark sensor by blower.
<p>The printing position of small label is incorrect</p>	<ul style="list-style-type: none"> * Media sensor sensitivity is not set properly. * Label size is incorrect. * The parameter Shift Y in the LCD menu is incorrect. * The vertical offset setting in the driver is incorrect. 	<ul style="list-style-type: none"> * Calibrate the sensor sensitivity again. * Set the correct label size and gap size. * Press [MENU] → [SELECT] x3 → [DOWN] x6 → [SELECT] to fine tune the parameter of Shift Y. * If using the software BarTender, please set the vertical offset in the driver. 
<p>The left side printout position is incorrect</p>	<ul style="list-style-type: none"> * Wrong label size setup. * The parameter Shift X in LCD menu is incorrect. 	<ul style="list-style-type: none"> * Set the correct label size. * Press [MENU] → [SELECT] x 3 → [DOWN] x 5 → [SELECT] to fine tune the parameter of Shift X.
<p>Missing printing on the left or right side of label</p>	<ul style="list-style-type: none"> * Wrong label size setup. 	<ul style="list-style-type: none"> * Set the correct label size.
<p>RTC time is incorrect when reboot the printer</p>	<ul style="list-style-type: none"> * The battery has run down. 	<ul style="list-style-type: none"> * Check if there is a battery on the main board.
<p>Power and Error LEDs are blinking fast</p>	<ul style="list-style-type: none"> * Power switch OFF and ON too fast. 	<ul style="list-style-type: none"> * Turn off the printer and wait all LEDs are dark, and turn on the printer again.
<p>Wrinkle Problem</p>	<ul style="list-style-type: none"> * Print head pressure is incorrect. * Ribbon installation is incorrect. * Media installation is incorrect. * Print density is incorrect. * Media feeding is incorrect. 	<ul style="list-style-type: none"> * Make sure the label guide touch the edge of the media guide. * Make sure label, paper core and ribbon are set at the center of the spindle.
<p>Gray line on the blank label</p>	<ul style="list-style-type: none"> * The print head is dirty. * The platen roller is dirty. 	<ul style="list-style-type: none"> * Clean the print head. * Clean the platen roller.
<p>Irregular printing</p>	<ul style="list-style-type: none"> * The printer is in Hex Dump mode. * The RS-232 setting is incorrect. 	<ul style="list-style-type: none"> * Turn off and on the printer to skip the dump mode. * Re-set the Rs-232 setting.

4.2 Print Head Pressure Adjustment Knob

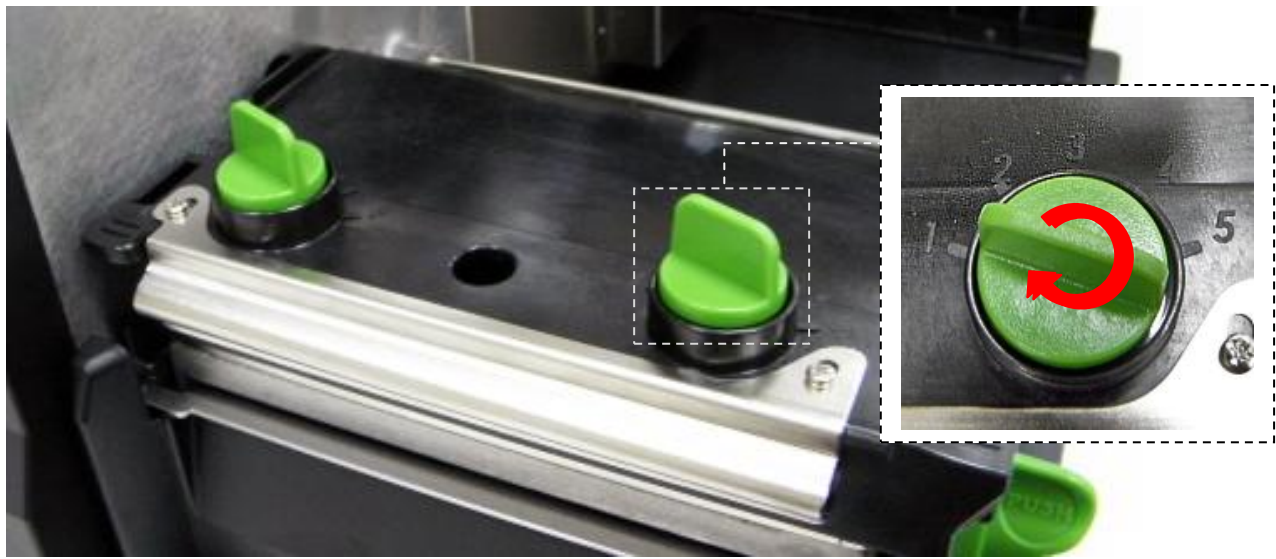

There are two conditions that will need to adjust the print head pressure.

1. Print with thick media
If the media thickness is larger than 0.19 mm, the larger pressure is required to get good quality printout.
2. Print with narrow media
If the media width is less than 4 inch wide the print head pressure will need to be adjusted to avoid ribbon wrinkle

There are 5 levels of pressure for adjustment. Level 1 is the minimum pressure and level 5 is the maximum pressure.

For example, if the label width is 4 inch, adjust both print head pressure adjustment knobs to the same level. If the label is less than 2 inch wide, increase the left side print head pressure by rotating the adjustment knob clockwise and decrease the right side pressure by rotating the adjustment knob counter-clockwise to level 1.

4.3 Mechanism Fine Adjustment to Avoid Ribbon Wrinkles

This printer has been fully tested before delivery. There should be no ribbon wrinkle presented on the media for general-purpose printing application. Ribbon wrinkle is related to the media thickness, print head pressure balance, ribbon film characteristics, print darkness setting...etc. In case the ribbon wrinkle happens, please follow the instructions below to adjust the printer parts.

<p>Adjustable Printer Parts</p>		
<p>Symptom</p>	<p>1. Wrinkle happens from label lower left to upper right direction (“ / ”)</p>	<p>2. Wrinkle happens from label lower right to upper left direction (“ \ ”)</p>
<p>Wrinkle Example</p>	<div style="display: flex; justify-content: space-around; align-items: center;"> <div data-bbox="363 1137 662 1518">  </div> <div data-bbox="837 1176 901 1310" style="text-align: center;">  </div> <div data-bbox="1061 1137 1359 1518">  </div> </div> <div style="text-align: center; margin-top: 10px;"> <div data-bbox="726 1355 973 1411" style="border: 1px solid black; padding: 5px; display: inline-block;"> <p style="color: blue; margin: 0;">Feed direction</p> </div> </div>	

Adjust the print head pressure adjustment knob

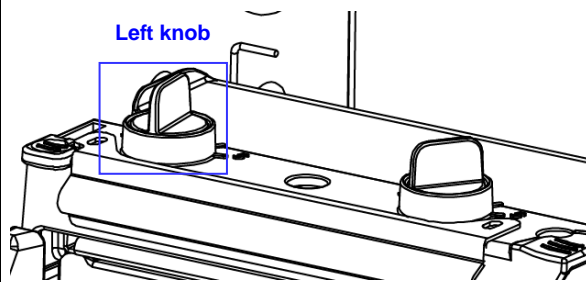

The print head pressure adjustment knob has 5 levels of settings. Clockwise direction adjustment is to increase the print head pressure. Counter Clockwise adjustment can decrease the print head pressure.

If the wrinkle on the label starts from the lower left side to upper right side, please do following adjustment.

1. Decrease the right side print head pressure adjustment knob setting 1 level per each adjustment then print the label again to check if wrinkle is gone.
2. If the right side print head adjustment knob setting has been set to index 1 (the lowest pressure index), please increase the left side print head pressure.
3. If the wrinkle can't be avoided, please contact the Customer Service Department of your purchased reseller or distributor for service.

Adjust the print head pressure adjustment knob

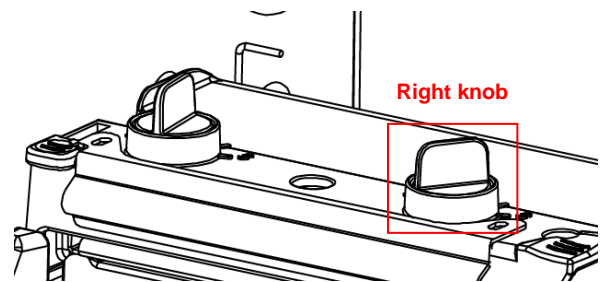

The print head pressure adjustment knob has 5 levels of settings. Clockwise direction adjustment is to increase the print head pressure. Counter Clockwise adjustment can decrease the print head pressure.

If the wrinkle on the label starts from the lower right side to upper left side, please do following adjustment.

1. Decrease the left side print head pressure adjustment knob setting 1 level per each adjustment then print the label again to check if wrinkle is gone.
2. If the left side print head adjustment knob level has been set to index 1 (the lowest index), please increase the right side print head pressure.
3. If the wrinkle can't be avoided, please contact the Customer Service Department of your purchased reseller or distributor for service.

4.4 Z-axis Mechanism Adjustment Knob

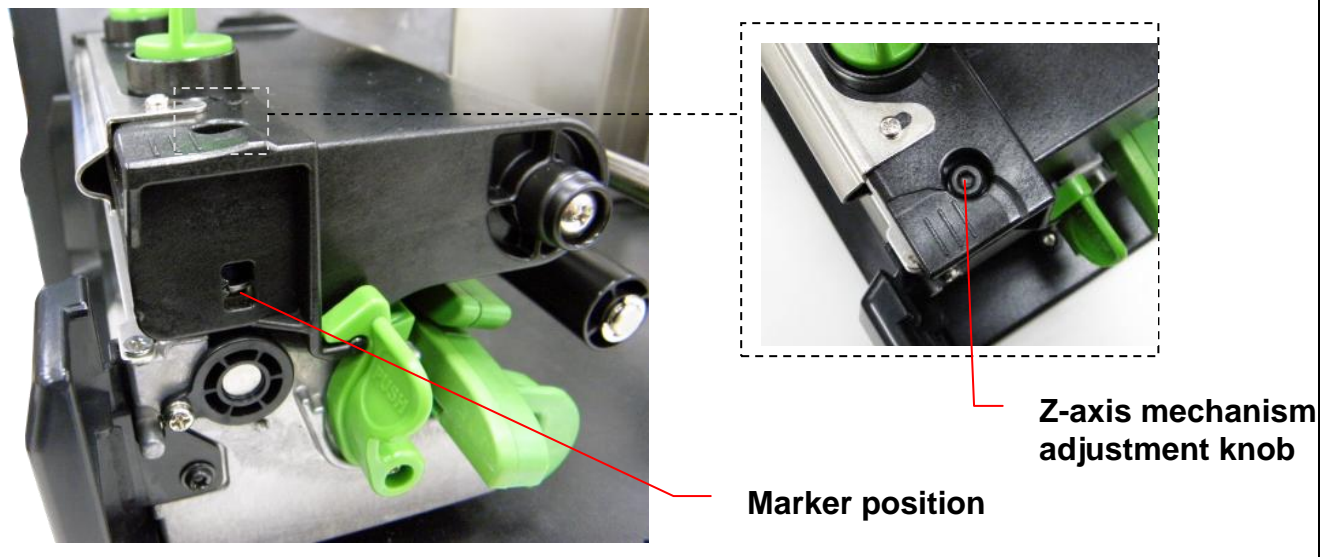

For narrow media, If change the print head pressure adjustment knob setting can't get the printout without ribbon wrinkle, the Z-axis mechanism adjustment knob should be adjusted to get the satisfied printout. This Z-axis mechanism adjustment knob is used to find tune the right side pressure of print head. Before find tune the print head right side pressure, please set the pressure adjustment knob to index "1" then use the Z-axis adjustment knob to fine tune the right side print head pressure. Please refer to the adjustment steps as below.

1. Use wrench to rotate the Z-axis mechanism adjustment knob (hexagonal head) at right side of print engine upper mechanism.

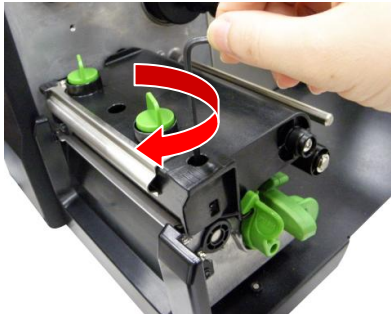
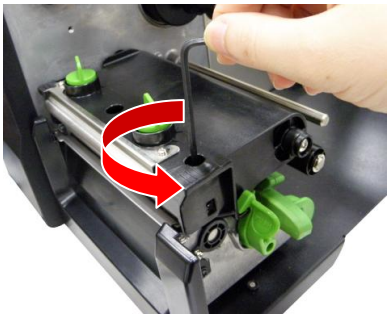
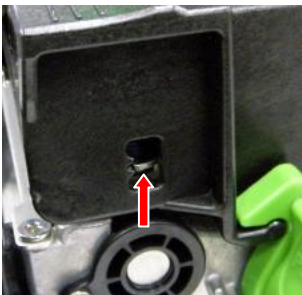
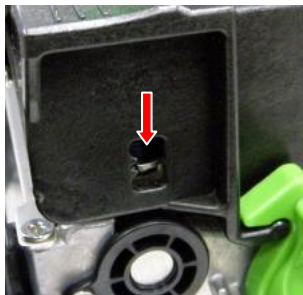
Clockwise direction adjustment is to decrease the right side print head pressure.	Counter Clockwise adjustment can increase the right side print head pressure.
	
Marker position will move down.	Marker position will move up.
	

2. Please be noted that print head right pressure find turn should be done by try-and-error. Rotate the Z-axis mechanism adjustment knob for a few circles by wrench and print again to check if the ribbon wrinkle remains. If the wrinkle still remains, please turn the Z-axis mechanism adjustment knob clockwise about 1/4 circle each time for adjustment.

5. MAINTENANCE

This session presents the clean tools and methods to maintain your printer.

1. Please use one of following material to clean the printer.

- Cotton swab (Head cleaner pen)
- Lint-free cloth
- Vacuum / Blower brush
- 100% ethanol

2. The cleaning process is described as following

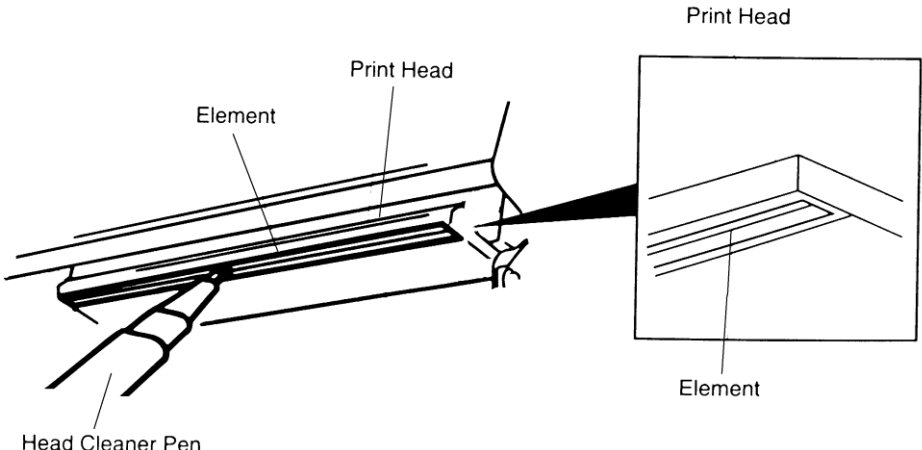
Printer Part	Method	Interval
<p>Print Head</p>	<ol style="list-style-type: none"> 1. Always turn off the printer before cleaning the print head. 2. Allow the print head to cool for a minimum of one minute. 3. Use a cotton swab (Head cleaner pen) and 100% ethanol to clean the print head surface. 	<p>Clean the print head when changing a new label roll</p>
	 <p>The diagram illustrates the cleaning process for the print head. It shows a 'Head Cleaner Pen' being used to clean the 'Print Head' surface. The 'Print Head' is shown with multiple 'Element' components. A detailed view of the 'Print Head' shows the 'Element' components.</p>	
<p>Platen Roller</p>	<ol style="list-style-type: none"> 1. Turn the power off. 2. Rotate the platen roller and wipe it thoroughly with 100% ethanol and a cotton swab, or lint-free cloth. 	<p>Clean the platen roller when changing a new label roll</p>
<p>Sensor</p>	<p>Compressed air or vacuum</p>	<p>Monthly</p>
<p>Exterior</p>	<p>Wipe it with water-dampened cloth</p>	<p>As needed</p>
<p>Interior</p>	<p>Brush or vacuum</p>	<p>As needed</p>

Note:

- Do not touch printer head by hand. If you touch it careless, please use ethanol to clean it.
- Please use 100% Ethenol. DO NOT use medical alcohol, which may damage the printer head.
- Regularly clean the print head and supply sensors once change a new ribbon to keep printer performance and extend printer life.

UPDATE HISTORY

Date	Content	Editor
2012/6/14	Add section 3.15 for print engine module info	Camille
2012/9/28	Modify section 3.13 and 3.14	Camille



TSC Auto ID Technology Co., Ltd.

Corporate Headquarters

9F., No.95, Minquan Rd., Xindian Dist.,
New Taipei City 23141, Taiwan (R.O.C.)

TEL: +886-2-2218-6789

FAX: +886-2-2218-5678

Web site: www.tscprinters.com

E-mail: printer_sales@tscprinters.com

tech_support@tscprinters.com

Li Ze Plant

No.35, Sec. 2, Ligong 1st Rd., Wujie Township,
Yilan County 26841, Taiwan (R.O.C.)

TEL: +886-3-990-6677

FAX: +886-3-990-5577